

Multi-Frequency Electromagnetic Profiler “AEMP-14”

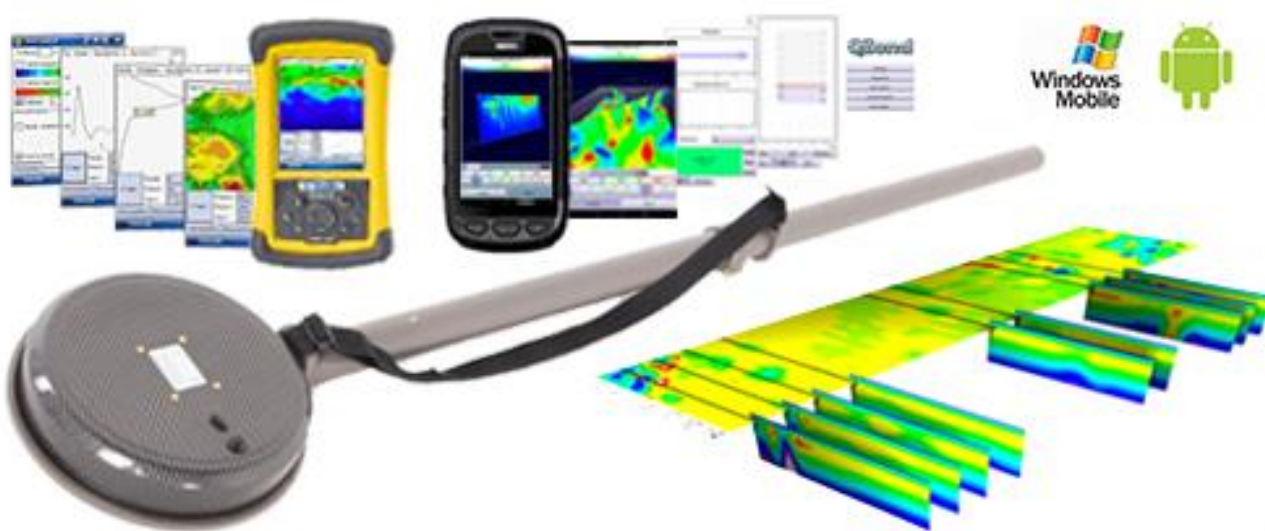

USER MANUAL THEORY

Before using the device read the instructions

WARNING:

- The AEMP-14 geophysical electromagnetic scanner is internally powered equipment (1x12V)
- Equipment type is continuous operation.
- If the equipment is receiving or causing interference, the equipment should be relocated away from the other equipment.
- There is no preventive inspection or maintenance required on the system or on parts of the system.
- Remove the battery if the equipment is not going to be used for prolonged time.
- Environmental requirements for storage and transport:
Ambient temperature: -40C to +60C
Relative humidity: 10% to 80%
Atmospheric pressure: 500hPa to 1060hPa



Follow local governing requirements when disposing of equipment or batteries



CAUTION: General Warning – refer to accompanying documents

© Copyright

All rights reserved. Under the copyright laws, this manual may not be copied in whole or as a part, without the written consent of KB "Electrometry" (Russia). Copying includes translation into another language.

KB "Electrometry" (Russia) reserve the right to change the designs and specifications of their products at any time without prior notice.

TABLE OF CONTENTS

GENERAL DESCRIPTION OF AEMP-14.....	4
PHYSICAL BASIS OF ELECTROMAGNETIC SOUNDING.....	4
PHYSICAL MODEL OF AEMP-14.....	6
SAFETY PRECAUTIONS.....	9
DATA ACQUISITION PROCEDURE.....	10
Preparation of the device for field work.....	10
Preparation of work site.....	10
Data acquisition process.....	10
ORIENTATION OF EMS EQUIPMENT (AEMP-14 AKA NEMFIS).....	11
QZOND SOFTWARE FOR AEMP-14 CONTROL.....	12
FREQUENTLY ASKED QUESTIONS.....	13
MAIN MENU.....	14
SETTINGS.....	15
EQUIPMENT.....	16
PROBE.....	18
NAVIGATION.....	19
ALTIMETER.....	20
NEW SESSION.....	21
CONTINUE SESSION / VIEW SESSION.....	22
SESSION MENU.....	23
SESSION PAGE.....	24
SESSION SETTINGS.....	25
MAP PAGE.....	26
ADD TRACKS ^[1]	27
INFO PAGE.....	29
TRACK SCANNING.....	30
3D VISUALIZATION.....	32
MANUAL NAVIGATION IN SINGLE MEASUREMENT MODE.....	36
MANUAL NAVIGATION IN CONTINUOUS MEASUREMENT MODE WITHOUT CHECKPOINTS.....	38
MANUAL NAVIGATION IN CONTINUOUS MEASUREMENT MODE WITH CHECKPOINTS.....	39
ODOMETER NAVIGATION IN SINGLE MEASUREMENT MODE.....	41
ODOMETER NAVIGATION IN CONTINUOUS MEASUREMENT MODE.....	42
GPS / EXTERNAL GPS NAVIGATION IN SINGLE MEASUREMENT MODE.....	43
GPS / EXTERNAL GPS NAVIGATION IN CONTINUOUS MEASUREMENT MODE.....	44
PC SOFTWARE – STEP 1.....	46
IISYSTEM.....	46
MAIN MENU.....	47
TOOLS - PROCESSING.....	48
LAYOUT.....	49
TRACK.....	50
PC SOFTWARE – STEP 2.....	54
ISYSTEM.....	54
iSystem Software.....	55
<i>I</i> System installation procedure.....	55
Data load.....	55
Data processing.....	55
Maps.....	56
Cross-sections.....	57
Automatic visualization of maps and cross-sections.....	57
Surfer settings.....	57
Diagrams.....	58
Cross-section with Topography**.....	58
Document Set creation**.....	58
Quazi 3D view.**.....	59
Examples.....	59

GENERAL DESCRIPTION OF AEMP-14

Electromagnetic multi-frequency sounding device AEMP-14 is developed in Laboratory of EM fields of Institute of Geophysics, Russian Academy of Sciences, Siberian Branch. The manager of the Laboratory – Dr. Michael Epov; manager of the device development group – Dr. Alexander Manstein.

PHYSICAL BASIS OF ELECTROMAGNETIC SOUNDING

Electromagnetic sounding is well known as a powerful tool for the study of the Earth crust at various depths – from few centimeters up to deep mantle. The technology of this study is based on the detection of peculiarities of spatial distribution of electromagnetic fields induced in the electrically inhomogeneous media by different sources. The task of the electromagnetic sounding depends on the problem investigated. So, for deep crust sounding a natural powerful source – ionospheric current system – is used. For other task

– extraction of earthquake or volcano eruption electromagnetic precursors – the weak electromagnetic signals caused by the dynamic changes in the crust internal structure at various depths have to be extracted and ionospheric source is a powerful interference for this. And for the study of the upper part of the crust the active electromagnetic sounding with the artificial sources are widespread. The adequate interpretation of the field observation data gives possibility to get quantitative information about the geometric dimensions (size, depth) and electric parameters of inhomogeneity and also their dynamics.

In any case, electromagnetic sounding process must have a variable parameter, that allows to propagate to the various depths. Such a parameter can be time of measurement (Time Domain EM methods) or frequency (Frequency Domain methods).

Frequency domain electromagnetic induction sounding is the full title of the method, hardwired in AEMP-14 device.

The procedure of such a sounding consists of the following phases:

1. Transmitter transmits primary EM field of the first frequency.
2. The primary field acts upon the media.
3. The secondary EM field induces in the media on the first depth.
4. Receiver receipts the secondary field.
5. Transmitter transmits primary EM field of the second frequency....

The number of such steps depends on the number of frequencies.

PURPOSE AND APPLICATIONS OF SHALLOW DEPTH ELECTROMAGNETIC SOUNDING

AEMP-14 designed to study first ten meters of the Earth crust. The real depth of measurement depends on resistivity of the ground, however, can't exceed 7 m in real grounds because of limited sensibility of receivers. Meanwhile we can expect that in some special kind of media such as dry sands or ice the propagation depth can reach and even exceed 10 m.

Due to this propagation limit, the purpose of the unit is limited by study of geoelectric situation on the depth up to 7 m. The device can operate on 14 frequencies. It means that the data acquired can describe the geoelectric situation at 14 levels of depth. In horizontal plane the responding media is the ellipse with one constant axis length (2.5 m) and second axis length depending on the frequency 0.5 – 4 m. Having such a good resolution we can state that the unit is intended for 3D specification of geoelectrical parameters of the media at a depth up to 7 meters with heterogeneous inclusions dimensions 0.5 x 0.5 x 2.5 m or more. Meanwhile, the very contrast targets such as metal objects can be even smaller.

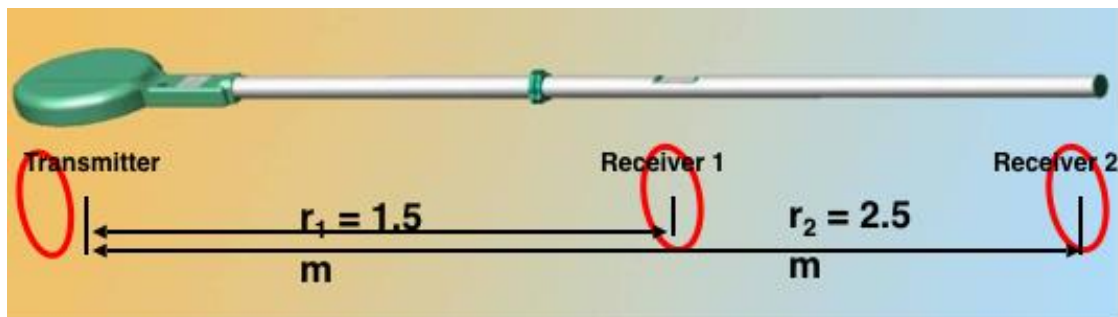

The applications of the device are:

- Archaeological survey;
- UXO determination;
- Subsurface tunnels and empties investigations;
- Quantitative assessment of water saturation of the ground;
- Assessment of HC waste in the ground;
- Searching both fresh and salty water source;
- Subsurface buildings condition control;
- Searching and localization of burial place of industrial waste;
- Source and volumes of water leakage in water supply and heating systems;
- Source and volumes of fuel/oil leakage in subsurface fuel tanks/pipelines;
- Definition of places of a lining of metal pipes and cables;
- Detail exploration of ore bodies;
- Environmental monitoring of dumping liquid mineralized waste.

PHYSICAL MODEL OF AEMP-14

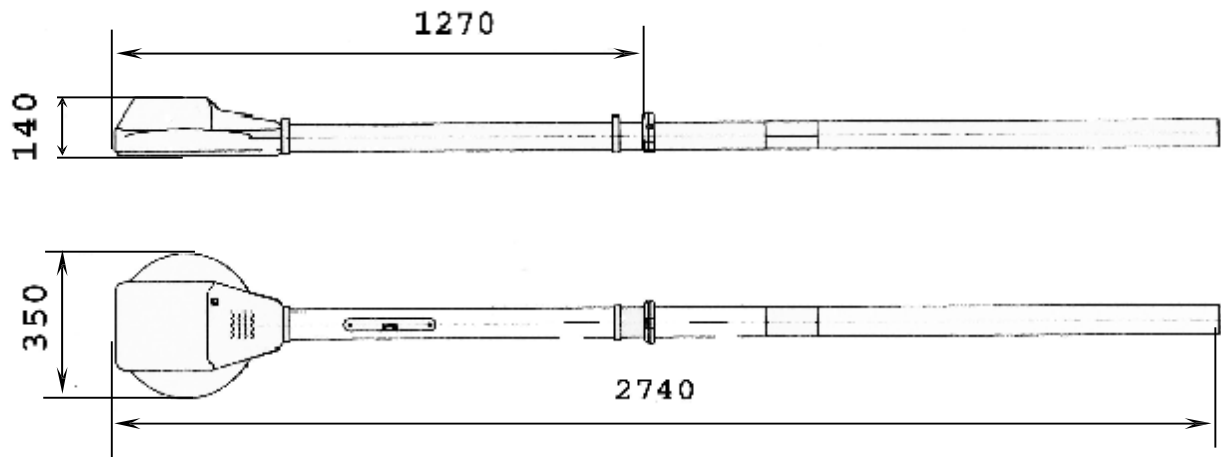

Basic components of AEMP-14 is shown on Figure 1.

AEMP-14 implements the frequency induction sounding as follow. Alternating magnetic field with controllable phase is generating consequently on several frequencies by transmitting loop (T). Measurement of real and imaginary component of media-/+induced field is to be effected on each frequency. Transmitter field compensates by contrary connection of receivers.

The receivers shaped (R_1 and R_2) especially to obtain the equity of M/r^3 ratios of the receivers on the average frequency in “on air” mode. There M is the product of receiver and transmitter magnetic momentum.

$$M = \mu_c \cdot n_r \cdot S_r \cdot I \cdot n_t \cdot S_t$$

Where μ_c magnetic permeability of the dipole' core; n_r – number of loops for receiver; S_r – square of a receiver loop; n_t – number of loops for transmitter; S_t – square of a transmitter loop; and r is the distance between center of the receiver and transmitter.

Each measurement has two stages: transmitter signal measurement to determine current value in transmitting dipole and measurement of media-induced field. The measured value in the output of AEMP-14 is the difference between electromotive forces of two receivers:

$$\varepsilon = \varepsilon_1 - \varepsilon_2$$

Taking in consideration only vertical component of magnetic field $H_z = H_z^0 e^{i\omega t}$

$$\text{For each receiver } \varepsilon_j = -i\omega\mu_0 \left(\frac{M_j M_t}{4\pi r_j^3} \right) h_{zj}; \quad j = 1, 2$$

Here $\omega = 2\pi f$; where f is the exiting frequency (Hz), M_t – momentum of transmitting dipole, M_1 and M_2 - momentum of receiving dipoles, $\mu_0 = 4\pi \cdot 10^{-7}$ henry/m, h_{zj} - magnetic number of the media for each receiver.

$$h_{zj} = 2/(k^2 r_j^2) [9 - e^{ikr_j} (9 - 9ikr_j - 4k^2 r_j^2 + ik^3 r_j^3)]. \quad [1]$$

where k is the wave number of the media $k = (i\omega\mu_0\sigma)^{1/2}$; where σ is the media electric conductivity (Sm).

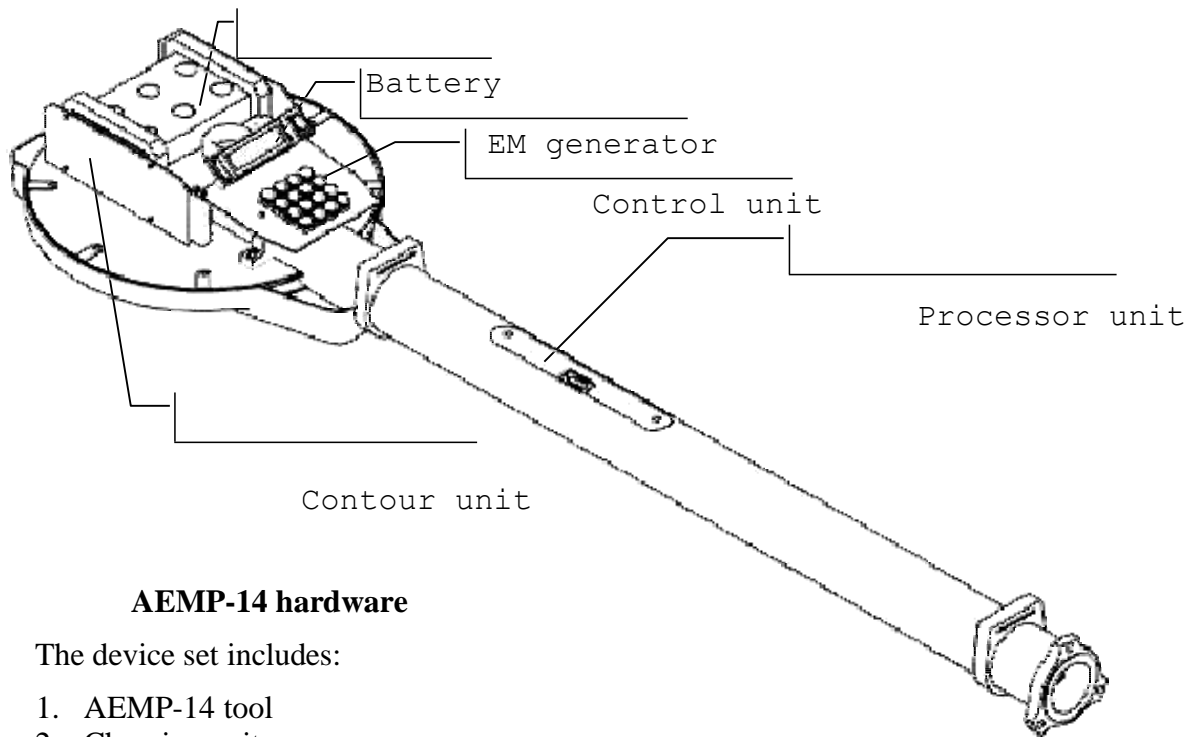

AEMP-14 hardware

The device set includes:

1. AEMP-14 tool
2. Charging unit
3. Measuring tapes
4. 10-mm wrench
5. Soft case
6. AEMP-14 head protector
7. RS 242 cable
8. Remote control unit
9. PDA
10. Software

AEMP-14 specification

Device dimensions: 2.75 x 0.3 x 0.15 m
 Device weight 8 kg
 Frequency range 2.5 – 250 kHz (table 1)
 Number of frequencies 1-14
 14-frequencies sounding time 2 sec

Table 1.

Frequency number	Frequency, kHz	Frequency number	Frequency, kHz
1	2.500	8	15.626
2	3.088	9	20.409
3	3.907	10	27.779
4	5.103	11	40.000
5	6.945	12	62.500
6	10.000	13	111.111
7	12.346	14	250.000

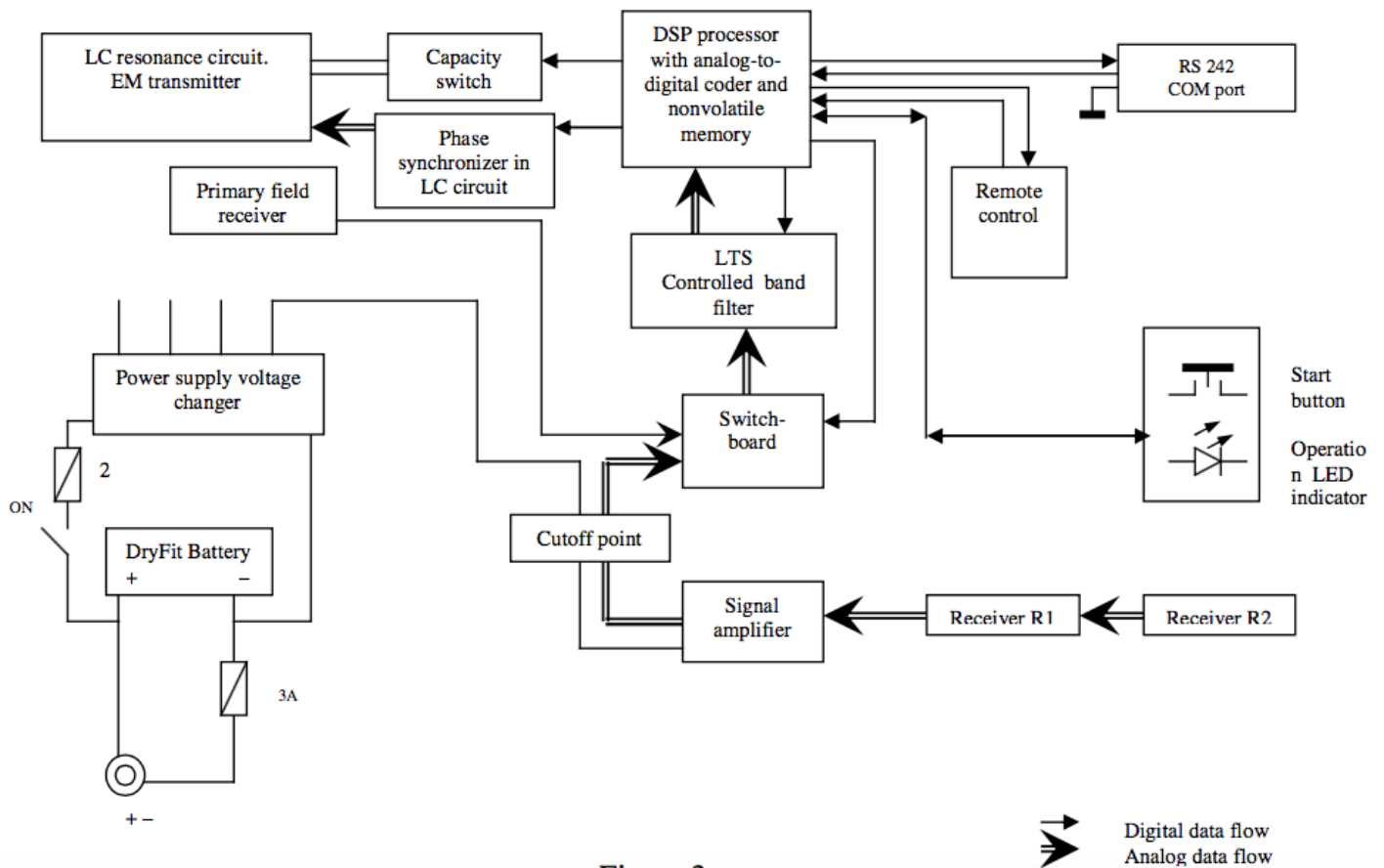

Figure 3.

AEMP-14 shaped as 8 feet long “banjo” with 3-inches diameter neck and 12-inches diameter, 5-inches high “drum” with LCD and keyboard on the top (see Figures 2 and 3). The charging unit intended for charging of the AEMP-14 unit on-board battery. The battery is Dryfit A500 battery 12V/10.0Ah of Sonnenschein. The battery is absolutely maintenance-free. The temperature range of the battery is $-30+50$ °C. However, at -15 °C the capacity of the battery reduces at 50%.

To charge the battery plug the output of charger to the DC input on top of the head of the tool; plug the input of charger to 220 V AC power point. The continuous voltage of battery reached 14 V and the battery is full.

SAFETY PRECAUTIONS

The device can't operate in conductive environment. Keep the working AEMP-14 out of big metal objects. If during operation a metal plate 30 x 20 cm is situated in less than 10 cm from the "head", phase of the primary field could not be measured and operation must be terminated by pressing Reset Button.

Keep dry.

All the components used in the device have the working temperature range $-20 \div +60$ °C.

Turn off the device before changing of the environmental air temperature. After changing of the environment air from negative to room temperature remove all the covers and let the device warm up during at least 1 hour. Current circuit during warming can damage multilayer board.

Blinking of battery weakness LED indicator (see Figure 3) means that the battery voltage is below 11.5 V and it's time to charge the battery. You can still acquire the data for some time, but sensitivity of the device will reduce.

DATA ACQUISITION PROCEDURE

Preparation of the device for field work

Be sure that the battery is full. We recommend to measure voltage on charging plug. The fully charged battery must show at least 13 V.

Assemble the tool.

Assemble GPS and Android control unit. Make sure that Bluetooth connection on control unit is turned on and AEMP-14/GPS is paired with it.

Preparation of work site

The device is ready to work now. It's time to prepare your work site. If you need to explore a linear object, it's just the matter to put measurement marks on your profile. We use 50-m measurement tapes.

If you need to explore an area, exploration area supposed to be divided to squares depending on the task (usually 1x1 m). We use 3 measurement tapes: 2 as directors on parallel borders of area and one as moving profile tape. This tape is used to move each time when a profile is done. AEMP-14 software is arranged to work with area data made by snake line as shown on the Figure 6.

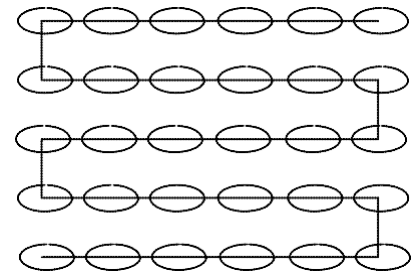

The Figure 6 presents an example of area sounding layout. The process is going picket by picket and profile by profile. The area is divided to M equal parallel profiles. Each profile has N pickets.

Data acquisition process

Turn the tool power switch on.

Attach and start external GPS.

While taking measurements, ALWAYS keep AEMP-14 oriented the same way in relation to the geographical position – i.e. when making turns at the end of profile, do not turn the unit itself! See diagram on the next page.

Do not take measurements while AEMP-14 is resting on the ground – galvanically connected with conductive media. All the measurements should be taken at least 20 cm above the ground. If it is tiring to hold the equipment, you can rest it on the ground from time to time, just do not collect measurements in that position.

Note: You can tie plastic bottles or other plastic props to the ends of AEMP-14 antenna, put it on those props and collect measurements (in single measurement mode, see measurement protocols below in QZOND software section).

Orientation of EMS equipment (AEMP-14 aka NEMFIS)

should be kept constant in relation to true geographical North during scanning of one area

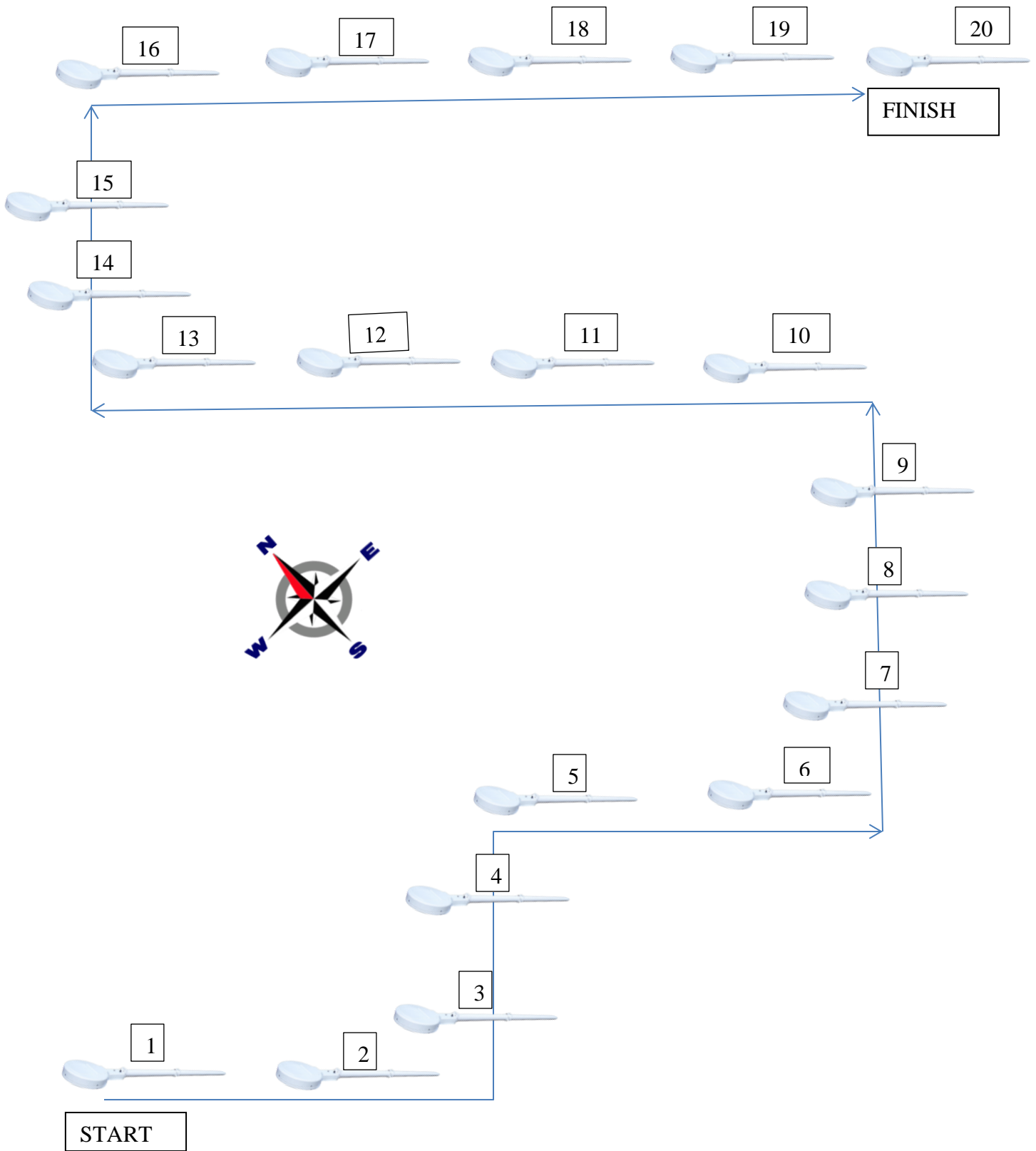

QZOND SOFTWARE FOR AEMP-14 CONTROL

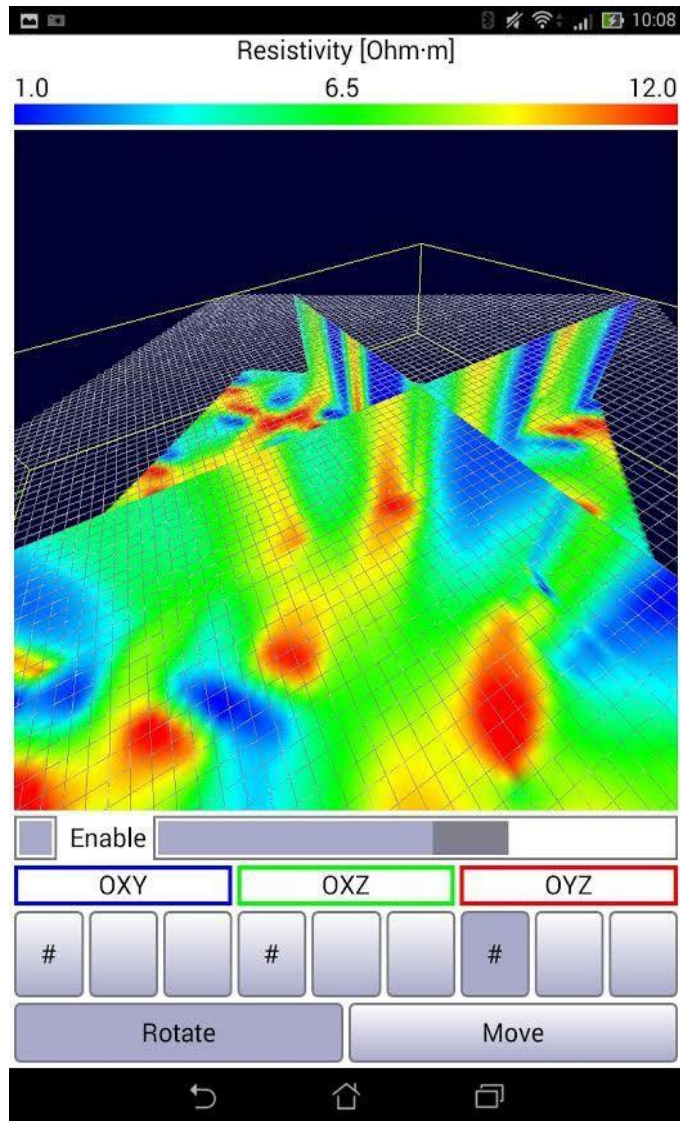

FREQUENTLY ASKED QUESTIONS

How to install QZond to my Android device?

Download QZond APK file to your Android device from the Internet or upload it via USB cable from your PC. Install QZond_XX.apk on Android device.

How can I get QZond APK file?

Please visit our this page <https://nemfis.ru/aemp-14/?lang=en> to find actual software version.

How can I use my equipment with QZond?

Turn on Bluetooth adapter of your Android device, search for Bluetooth devices and add your equipment (probes and external GPS receivers) to Bluetooth paired devices.

Where can I find my data files? Path is “/sdcard/QZond”.

How can I use my EMS/NEMFIS probe with QZond?

Put your EMS/NEMFIS-specific INI-file to “/sdcard/QZond” folder.

How can I report a bug?

Please send the message with bug to info@sibergeo.com .

MAIN MENU



1. Press to change general settings.
2. Press to choose equipment.
3. Press to begin new session.
4. Press to continue saved session.
5. Press to view saved session.
6. Press to close QZond.

SETTINGS

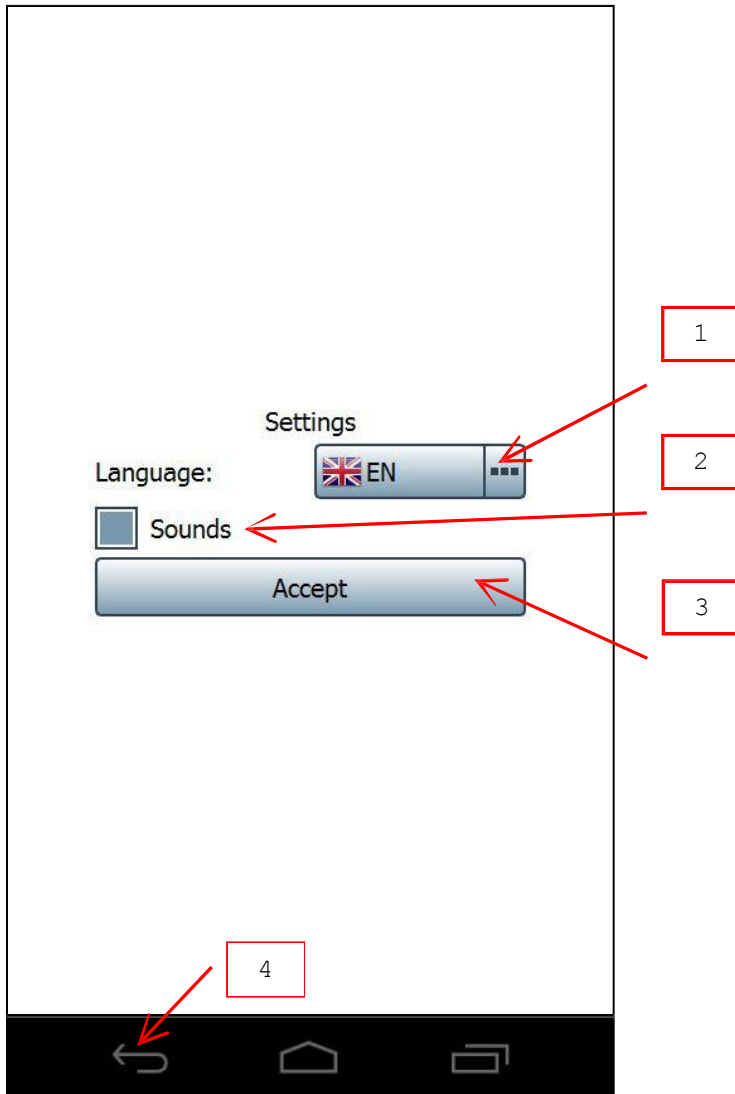

1. Choose QZond interface language ^[1].
2. Check to play sounds (recommended to hear that AEMP-14 is operating)
3. Press to accept changes.
4. Press to cancel.

[1] Accept changes and restart QZond to apply new interface language.

EQUIPMENT

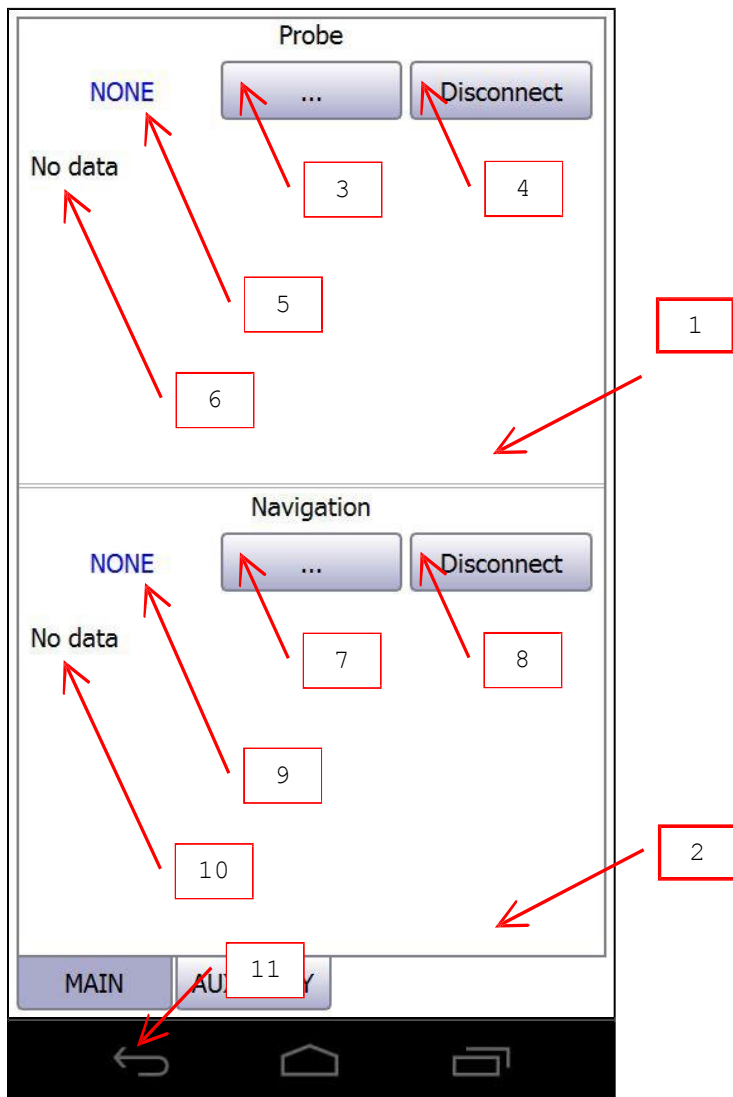

1. Probe panel.
2. Navigation panel.
3. Press to choose probe.
4. Press to disconnect current probe.
5. Current probe.
6. Current probe info.
7. Press to choose navigation.
8. Press to disconnect current navigation.
9. Current navigation.
10. Current navigation info.
11. Press to return to main menu.

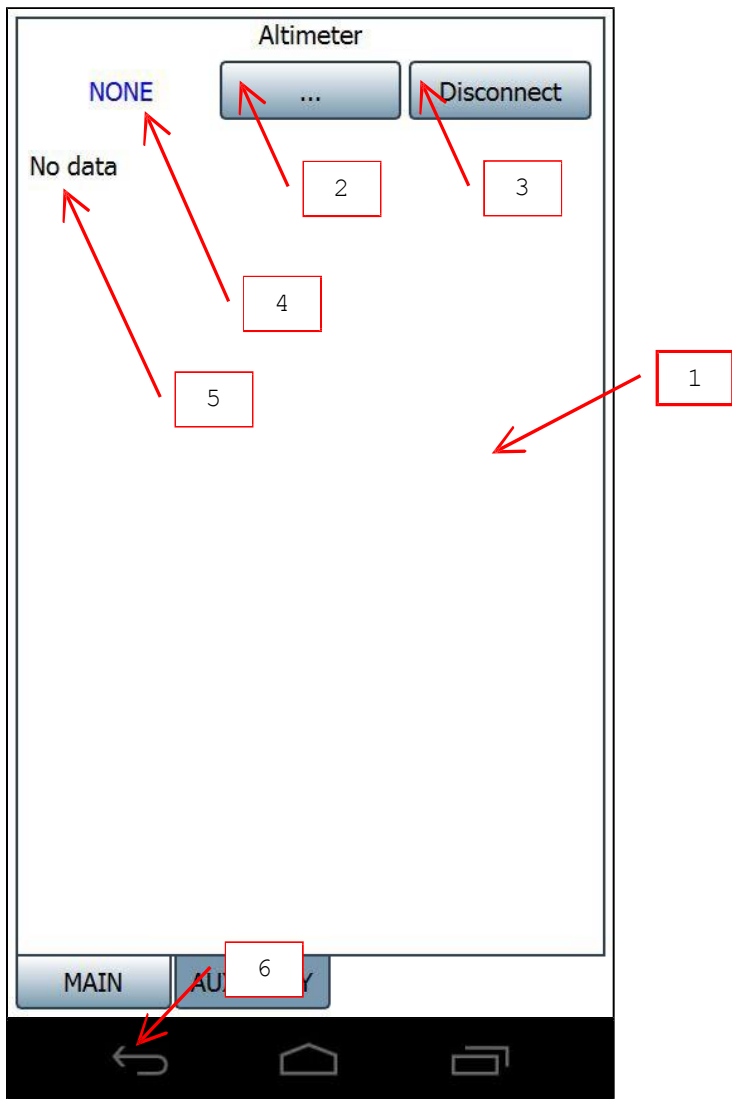

1. Altimeter panel.
2. Press to choose altimeter.
3. Press to disconnect current altimeter.
4. Current altimeter.
5. Current altimeter info.
6. Press to return to main menu.

PROBE

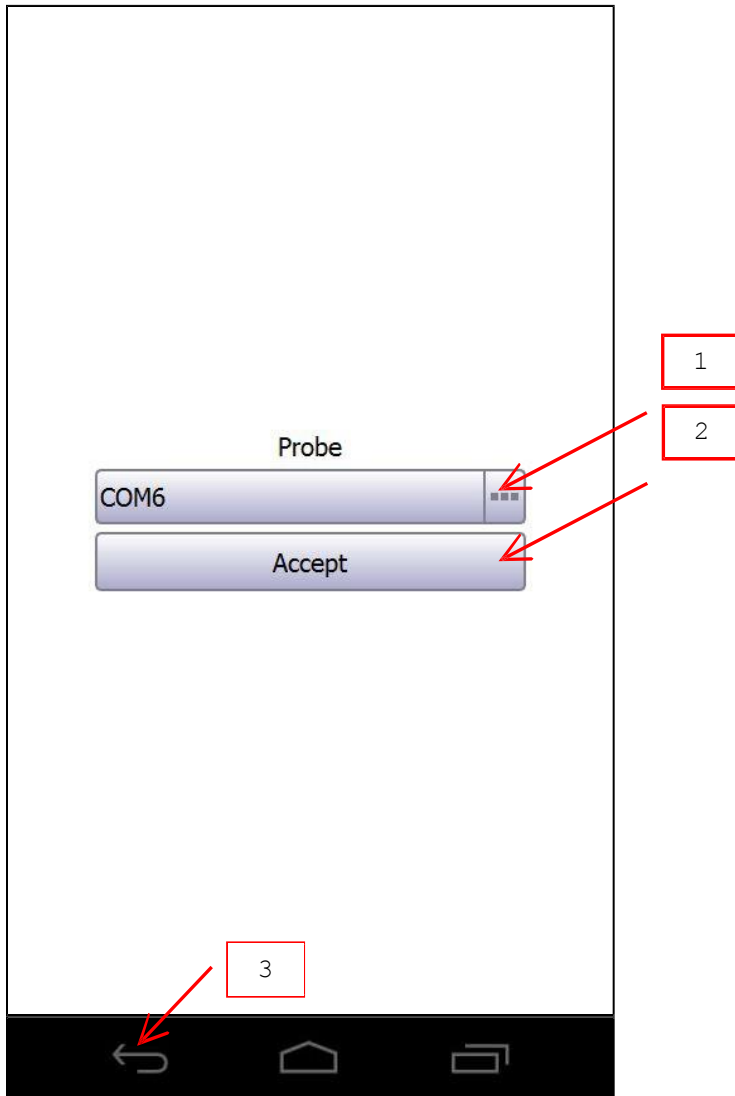

1. Choose probe to connect.
2. Press to open connection.
3. Press to cancel.

NAVIGATION

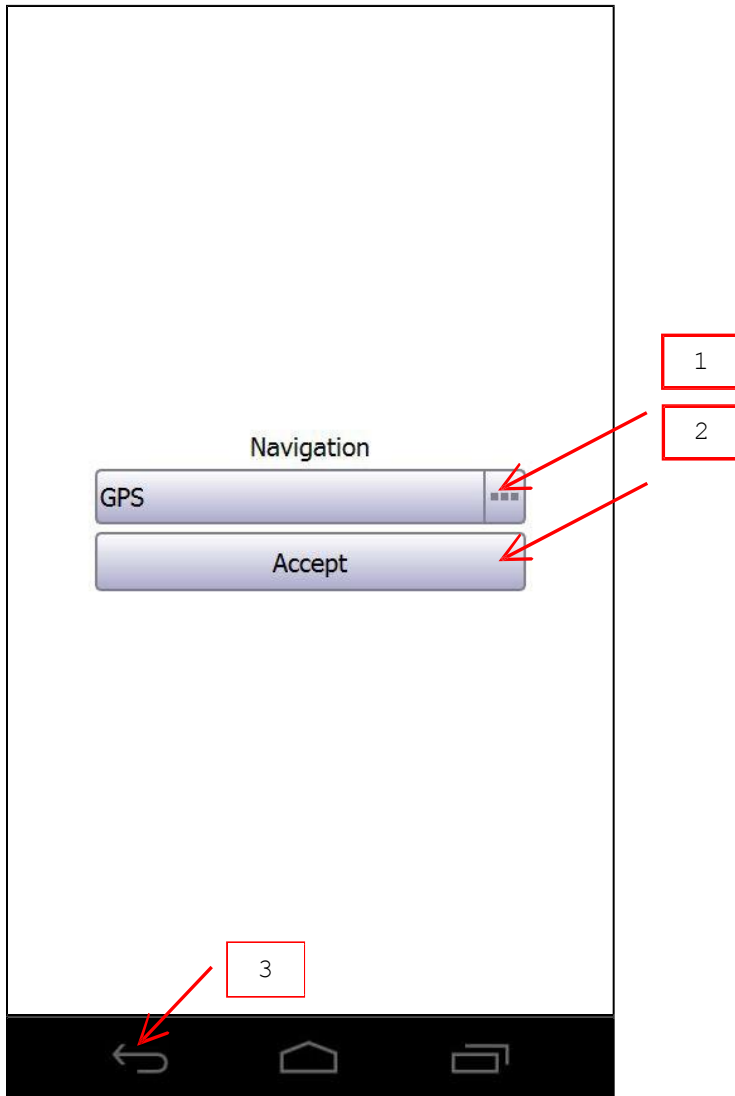

1. Choose navigation.
2. Press to start navigation.
3. Press to cancel.

ALTIMETER

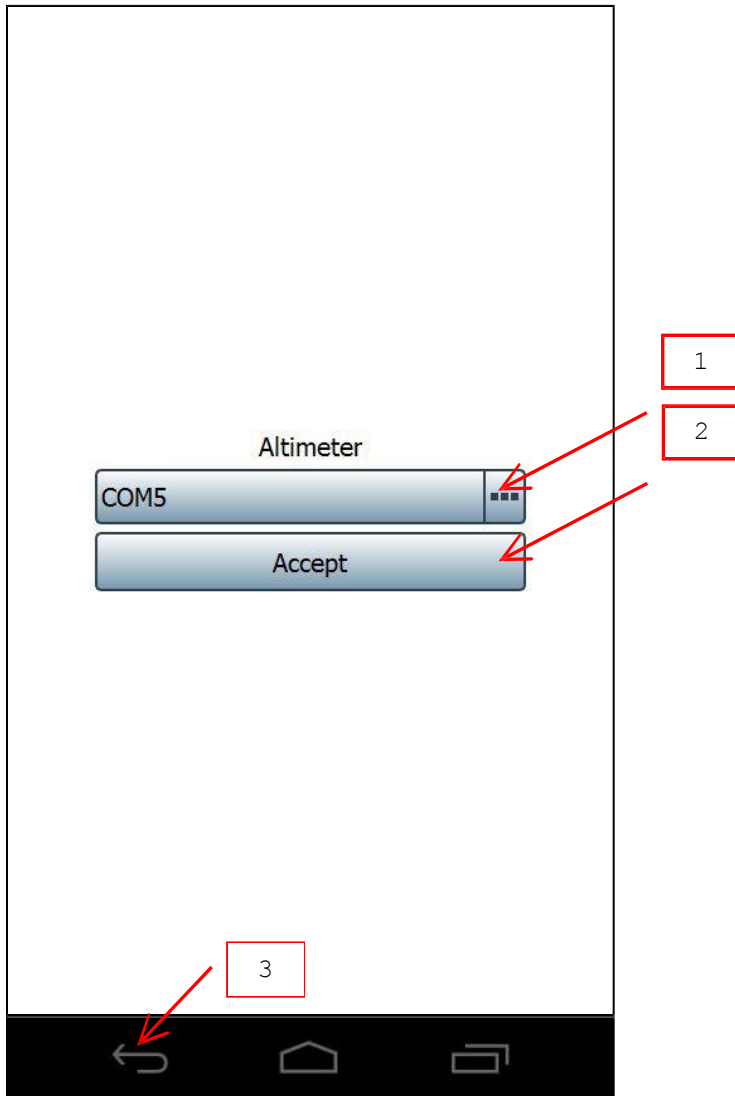

1. Choose altimeter to connect.
2. Press to open connection.
3. Press to cancel.

NEW SESSION

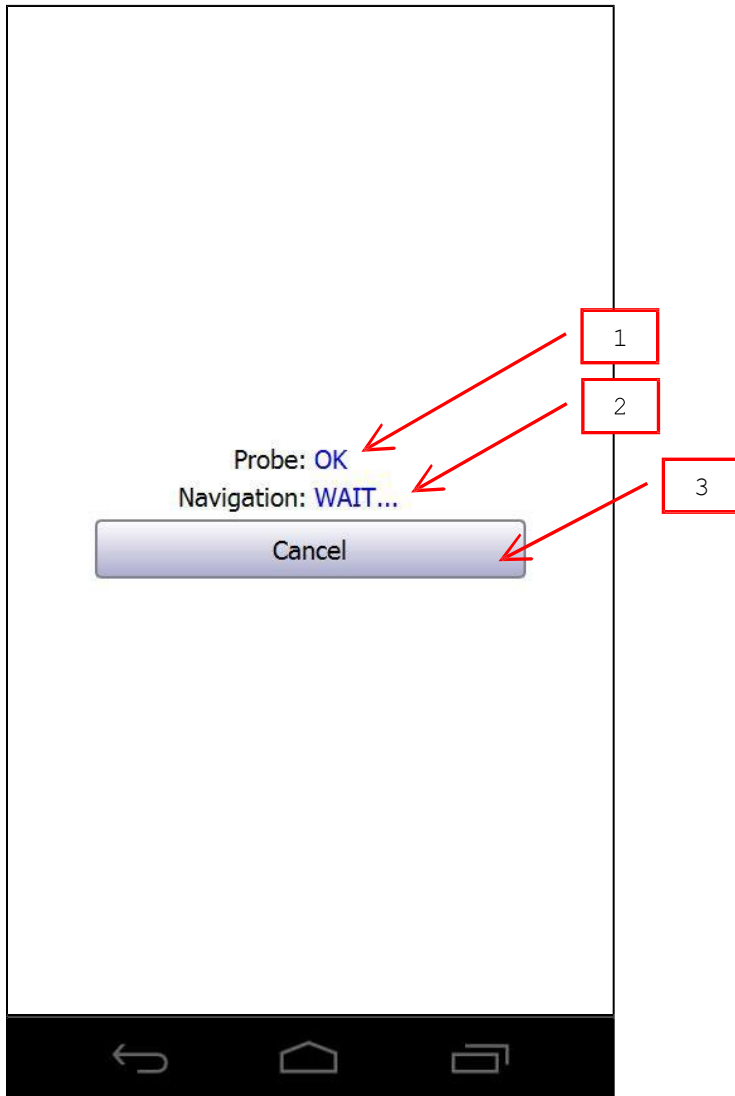

1. Probe state^[1].
2. Navigation state^[1].
3. Press to cancel.

[1] WAIT... = not ready, OK = ready, NONE = nothing selected.

CONTINUE SESSION / VIEW SESSION

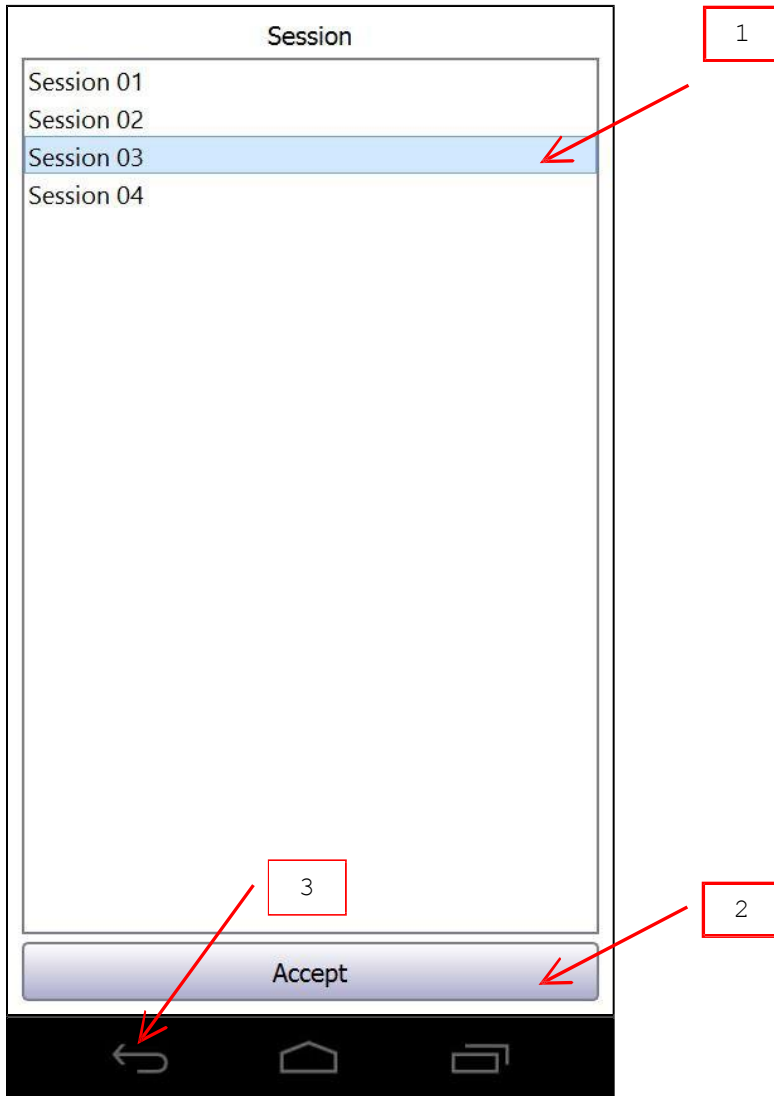

1. Choose session to continue or view.
2. Press to continue or view session.
3. Press to cancel.

SESSION MENU

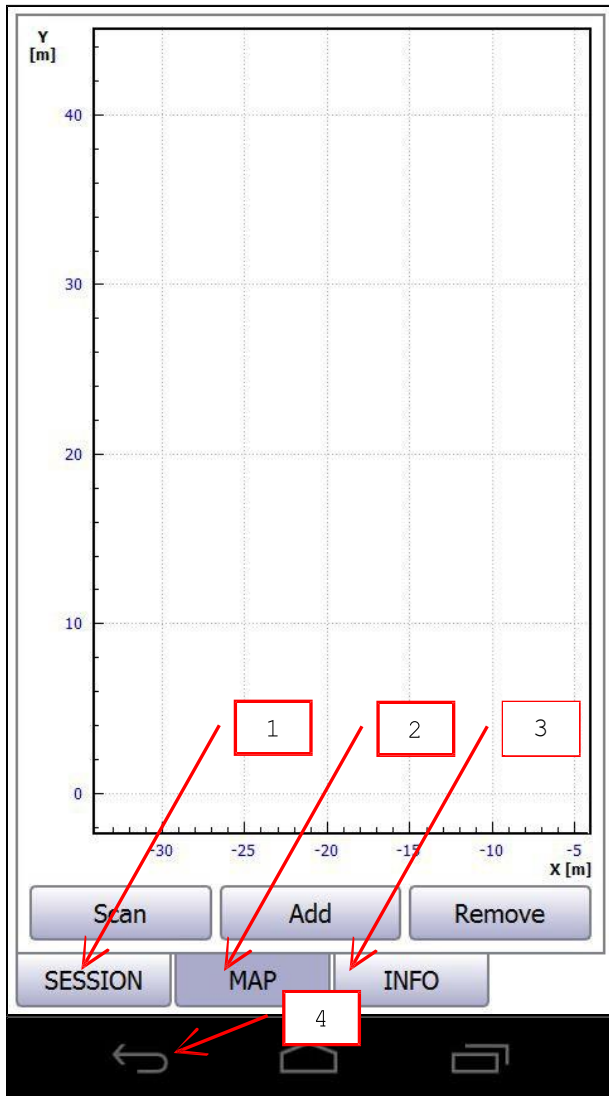

1. Session page.
2. Map page.
3. Info page.
4. Press to close session.

SESSION PAGE

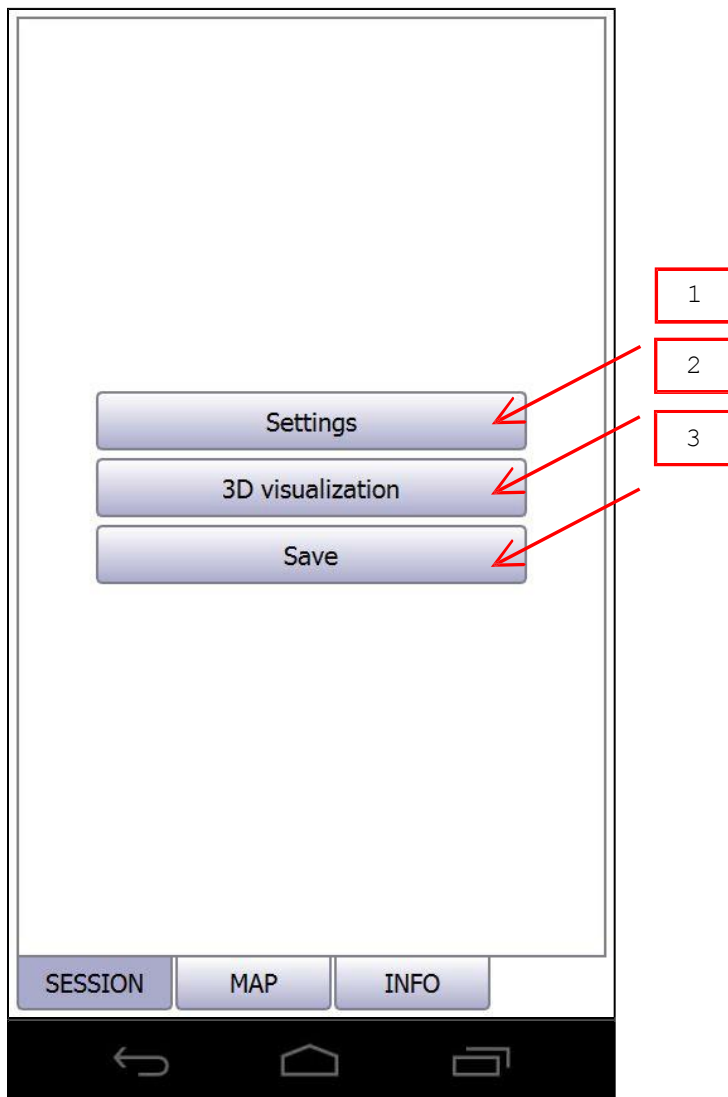

1. Press to change session settings.
2. Press to view data in 3D.
3. Press to save current session.

SESSION SETTINGS

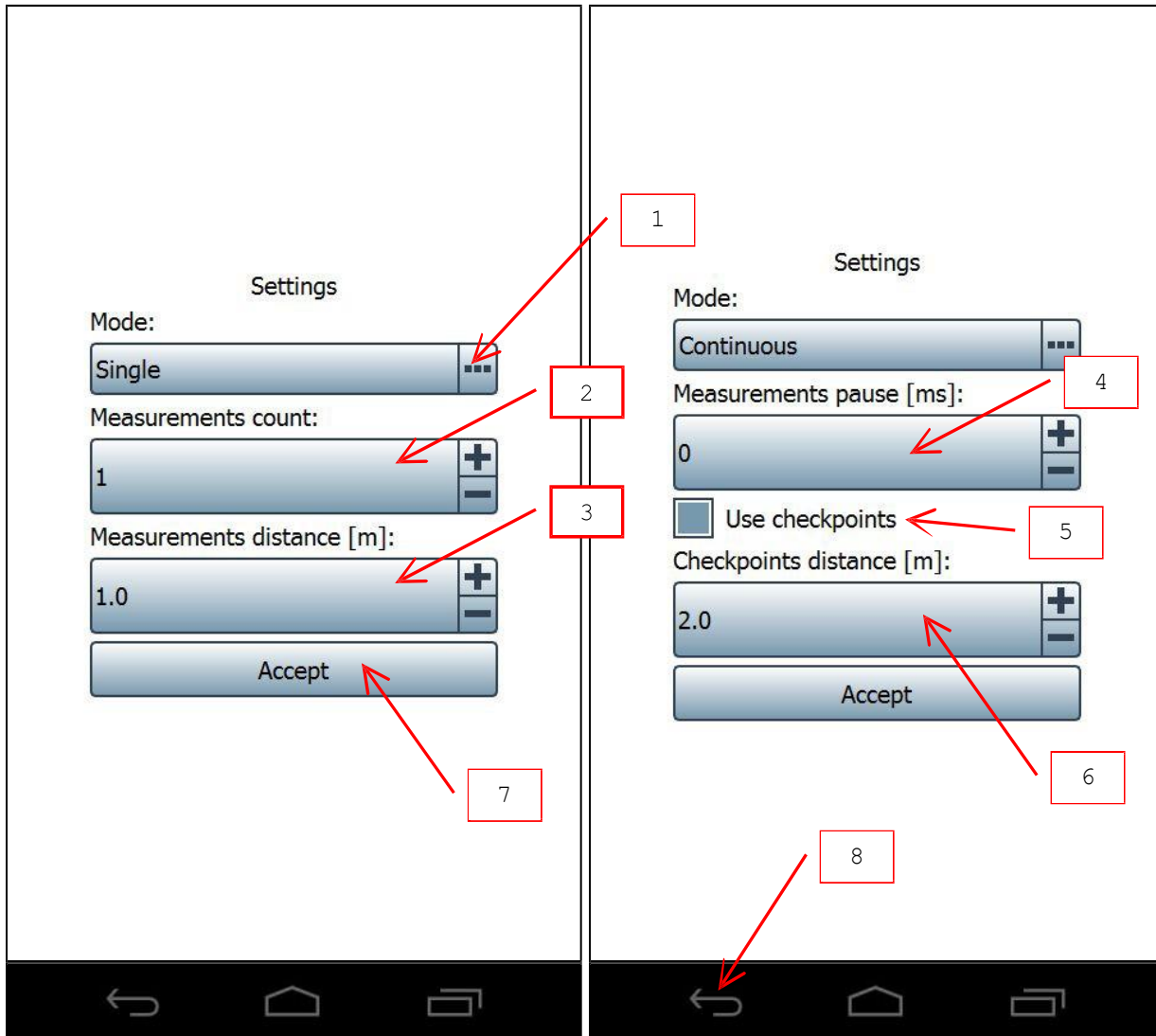

1. Choose single or continuous mode.
2. Choose measurements count in single mode.
3. Choose measurements distance in single mode^[1].
4. Choose measurements pause in continuous mode.
5. Check to enable checkpoints in continuous mode^[1].
6. Choose checkpoints distance in continuous mode^[1].
7. Press to accept changes.
8. Press to cancel.

[1] This setting is available for MANUAL navigation only.

MAP PAGE

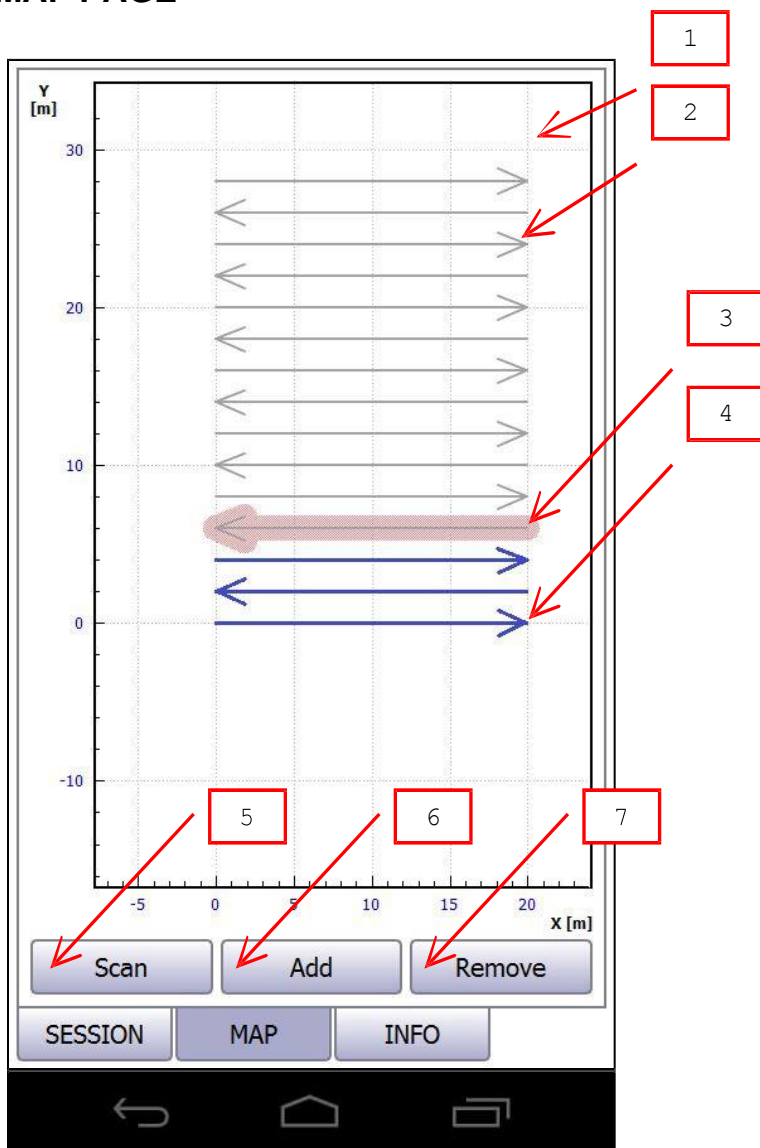

1. Map plot. Use pan^[1] and pinch^[2] gestures to navigate and zoom.
2. Gray tracks are not scanned (empty).
3. Current track. Press track to select.
4. Blue tracks are already scanned.
5. Press to scan current track.
6. Press to add new tracks.
7. Press to remove current track. [1]

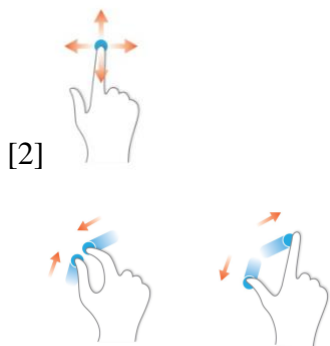

ADD TRACKS^[1]

The screenshot shows a mobile application interface for adding tracks. The dialog is titled "Add" and contains the following elements:

- X [m]:** A numeric input field with the value 0.0 and +/- buttons. Callout 1 points to the input field, and callout 2 points to the +/- buttons.
- Y [m]:** A numeric input field with the value 0.0 and +/- buttons. Callout 3 points to the input field, and callout 4 points to the +/- buttons.
- Length [m]:** A numeric input field with the value 30.0 and +/- buttons. Callout 5 points to the input field, and callout 6 points to the +/- buttons.
- Count:** A numeric input field with the value 15 and +/- buttons. Callout 7 points to the input field, and callout 8 points to the +/- buttons.
- Spacing [m]:** A numeric input field with the value 2.0 and +/- buttons. Callout 9 points to the input field, and callout 10 points to the +/- buttons.
- Orientation:** Two radio buttons labeled "Left" (selected) and "Right". Callout 11 points to the "Right" radio button.
- Rotation:** A slider control with a value of 0°. Callout 12 points to the slider.
- Buttons:** A large "Accept" button at the bottom and a "Cancel" button (represented by a back arrow) at the bottom left. Callout 13 points to the "Accept" button, and callout 14 points to the "Cancel" button.

At the bottom of the screen, there is a standard Android navigation bar with back, home, and recent apps icons.

1. X position of first track beginning.
2. Y position of first track beginning.
3. Length of tracks.
4. Tracks count.
5. Distance between neighbor tracks.
6. Tracks orientation relative to first track direction.
7. Tracks rotation around first track beginning.
8. Press to add tracks to map.
9. Press to cancel.

[1] This setting is available for MANUAL and ODOMETER navigations only.

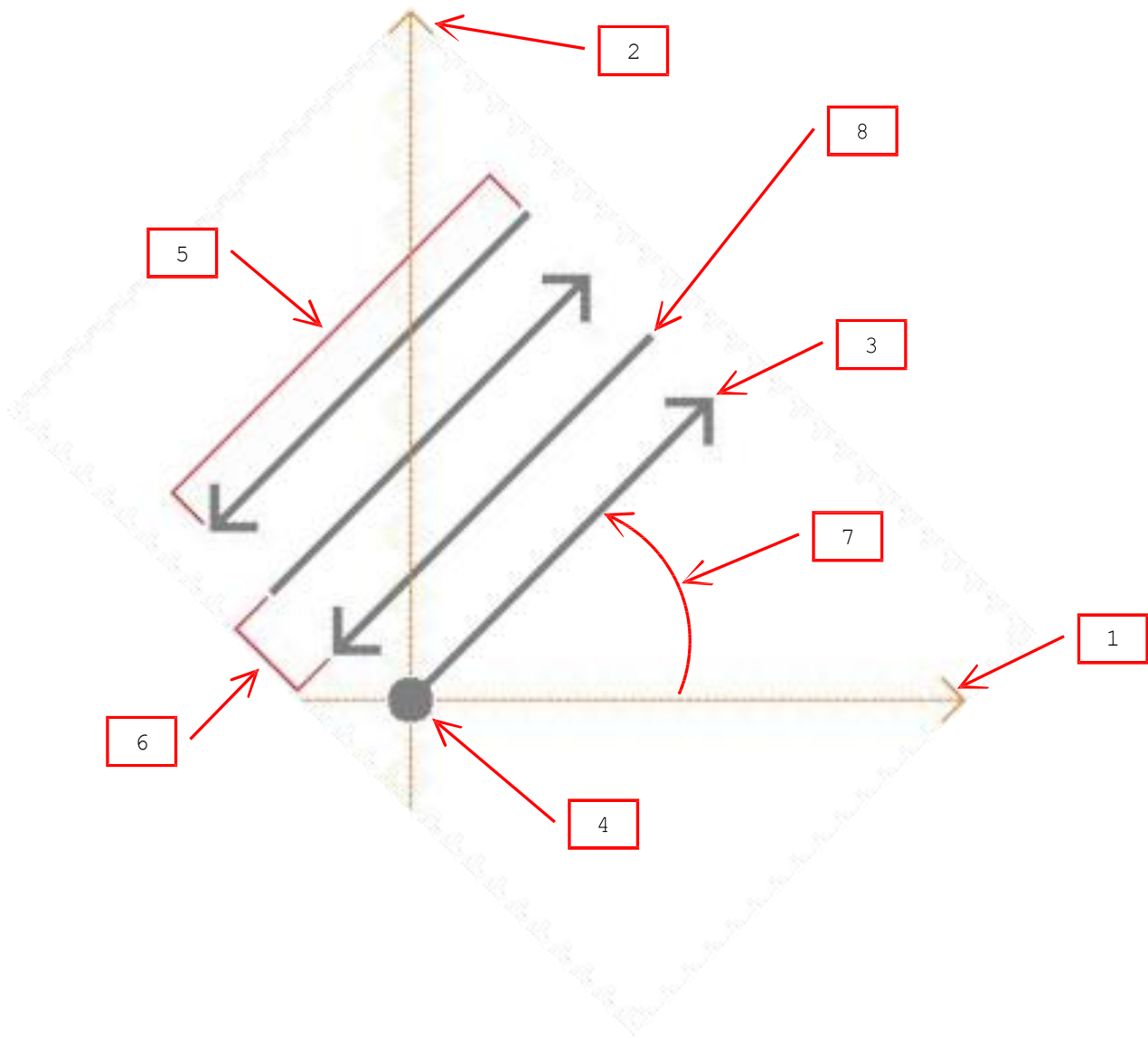

1. X axis.
2. Y axis.
3. First track.
4. $X = 0.0$ m, $Y = 0.0$ m.
5. Length = 10 m.
6. Spacing = 2.0 m.
7. Rotation = 45° .
8. Count = 4, orientation = left.

INFO PAGE

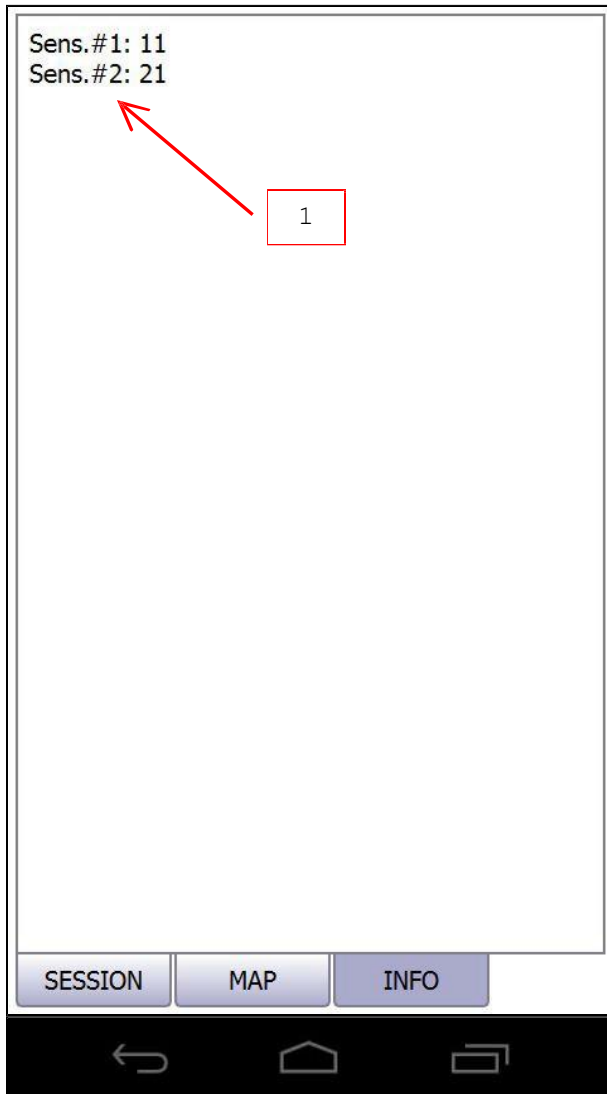

1. Equipment-specific info.

TRACK SCANNING

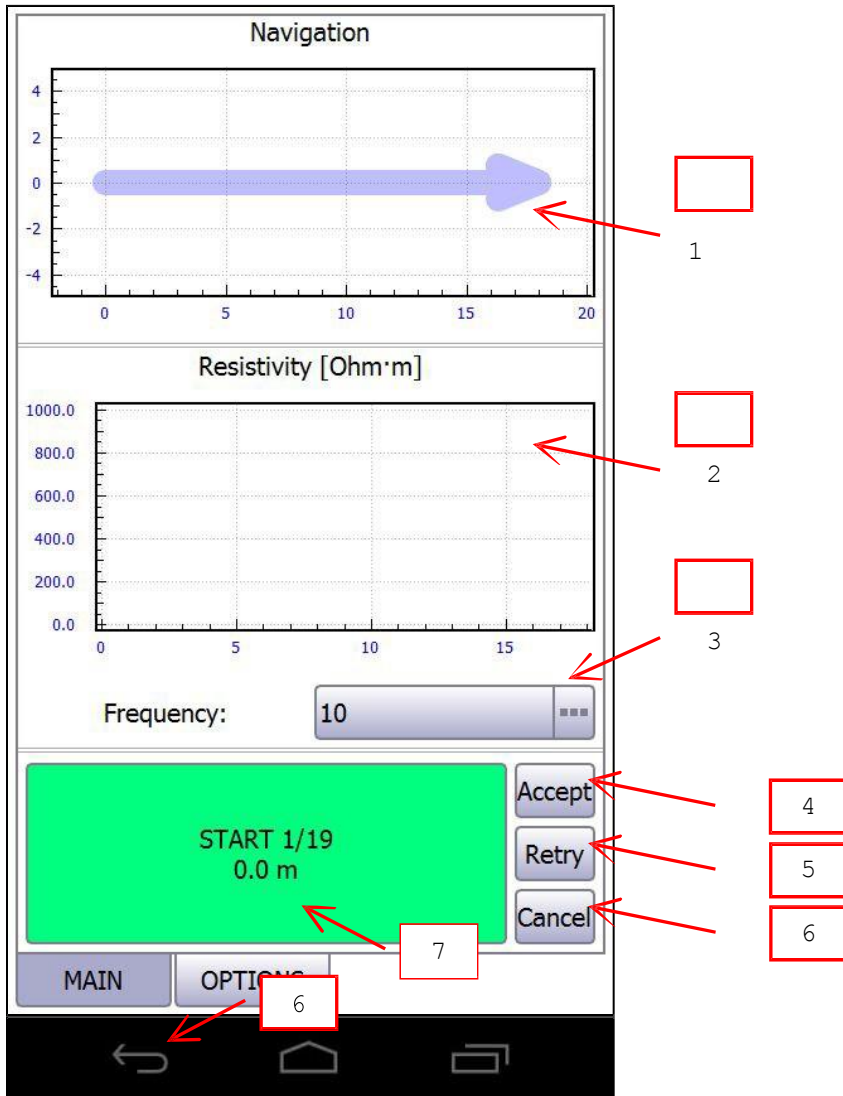

1. Track sketch.
2. Resistivity profile curve. Use pan^[1] and pinch^[2] gestures to navigate and zoom.
3. Probe-specific data view settings.
4. Press to accept track scanning.
5. Press to retry track scanning.
6. Press to cancel.
7. ACTION button.

[1]



[2]

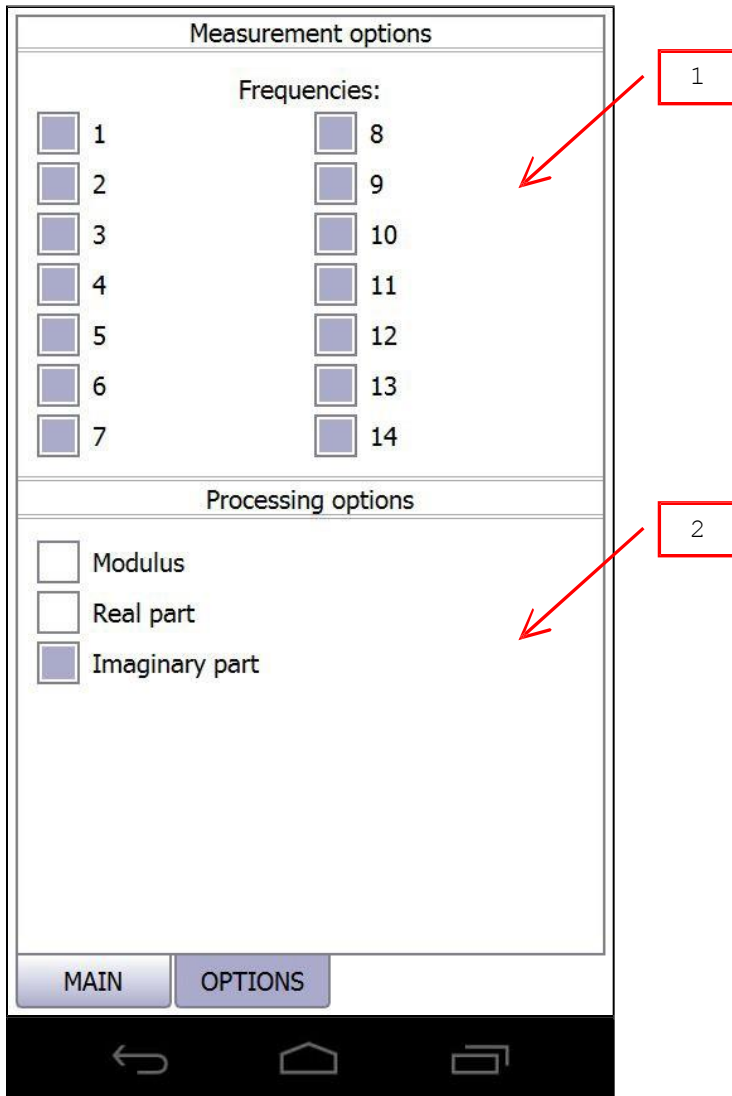

1. Probe-specific measurement options.
2. Probe-specific data processing options.

Measured signal component: the module (**Module**), real or quadrature a component (**Quadrature**), imaginary or inphase a signal component (**Inphase**).

3D VISUALIZATION

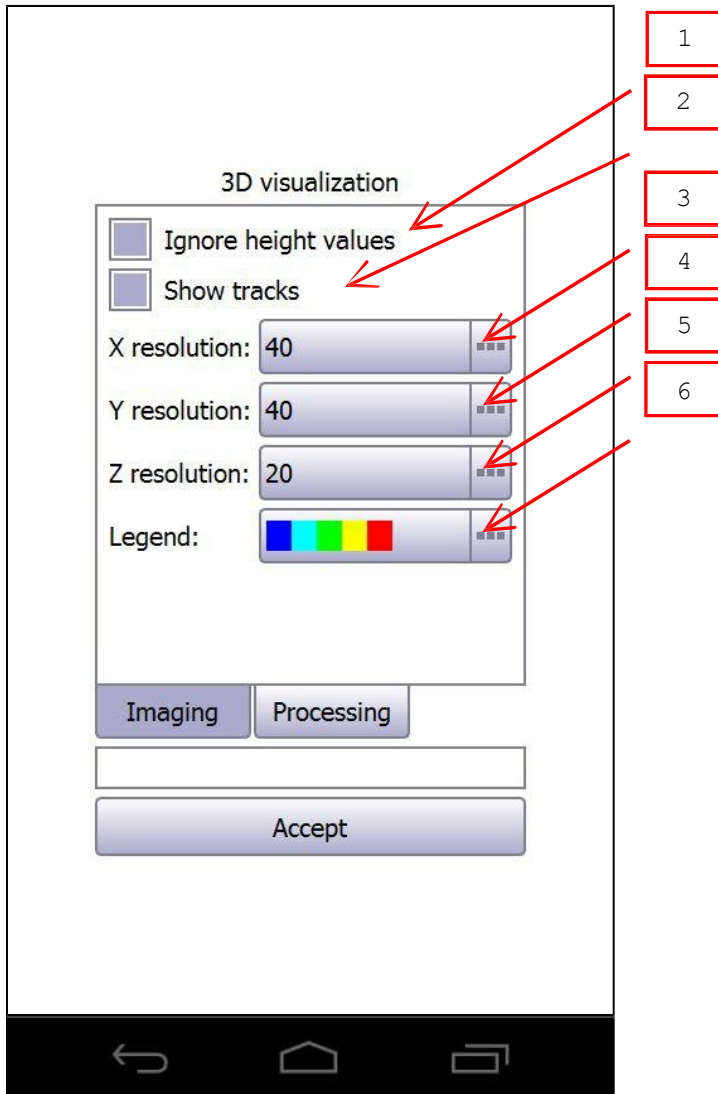

1. Check to assume that surface is flat.
2. Check to show tracks on surface.
3. X pixels image resolution.
4. Y pixels image resolution.
5. Z pixels image resolution.
6. Choose color legend.

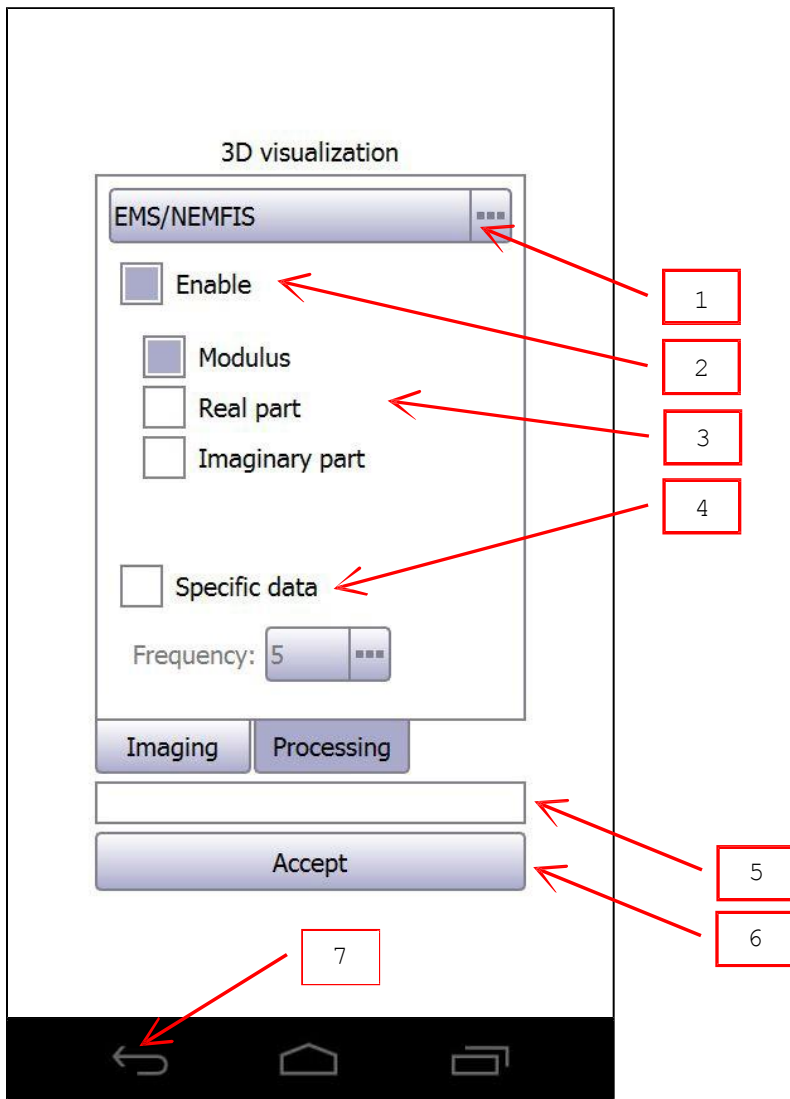

1. Choose probe to set up probe-specific data processing settings.
2. Check to enable probe data.
3. Probe-specific data processing settings.
4. Check to enable specific data only.
5. Progress indicator.
6. Press to accept image settings and build 3D image.
7. Press to cancel.

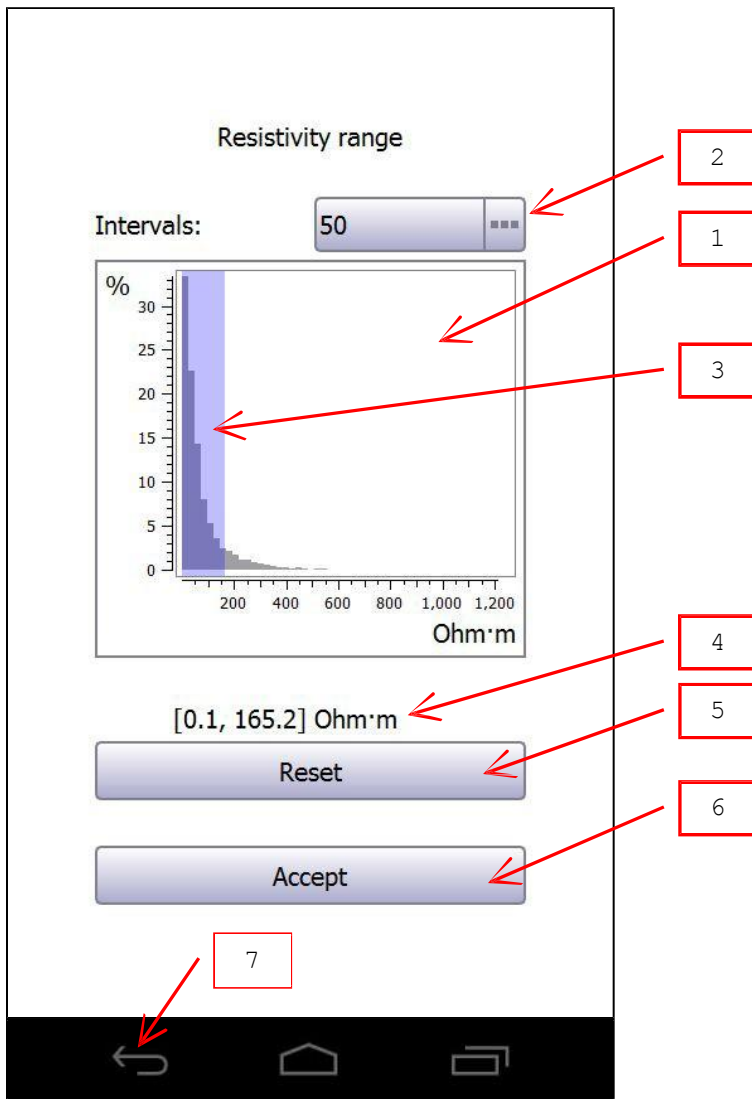

1. Resistivity bar chart.
2. Resistivity bar chart bars count.
3. Use pan^[1] gesture to choose resistivity range.
4. Current resistivity range.
5. Press to reset current resistivity range.
6. Press to accept resistivity range.
7. Press to cancel. [1]



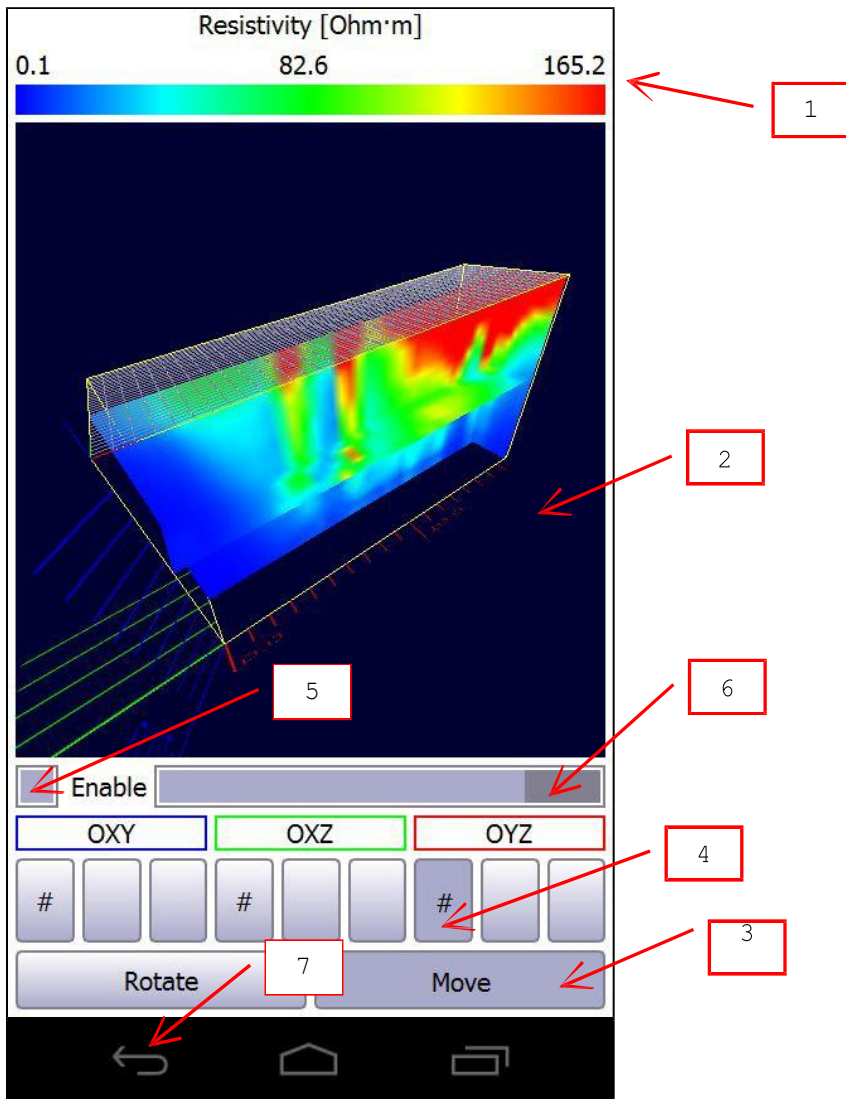

1. Resistivity color legend.
2. 3D image. Use pan^[1] and pinch^[2] gestures to move (rotate) and zoom image.
3. Choose pan gesture mode.
4. Choose 3D image slice to set up^[3].
5. Check to show current slice.
6. Choose current slice position.
7. Press to exit. [1]

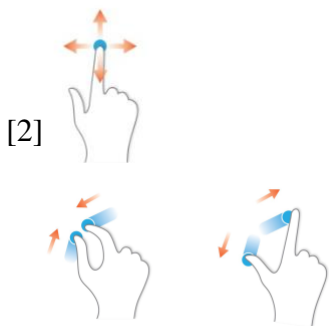

[3] Enabled slices are marked with “#” symbol.

MANUAL NAVIGATION IN SINGLE MEASUREMENT MODE

Track length = 8.0 m
Measurements distance = 2.0 m

1. Go to track beginning (0.0 m position).

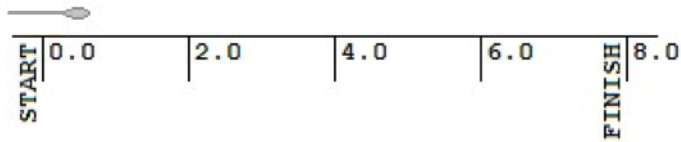

2. Press ACTION button to make measurement (first of five at 0.0 m position).

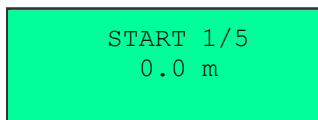

3. Go to next position (2.0 m position).



4. Press ACTION button to make measurement (second of five at 2.0 m position).

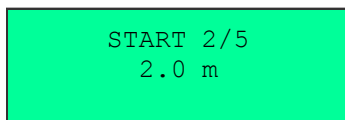

5. Go to next position (4.0 m position).

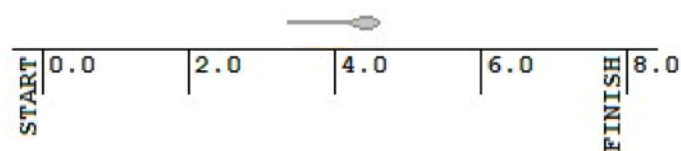

6. Press ACTION button to make measurement (third of five at 4.0 m position).

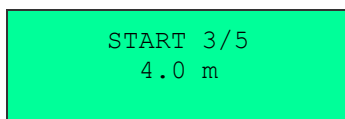

7. Go to next position (6.0 m position).

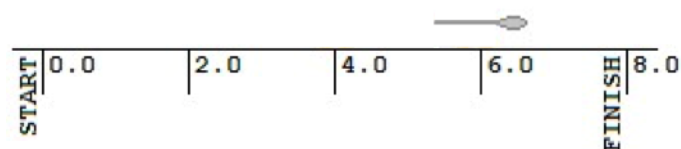

8. Press ACTION button to make measurement (fourth of five at 6.0 m position).

START 4/5
6.0 m

9. Go to next position (8.0 m position).

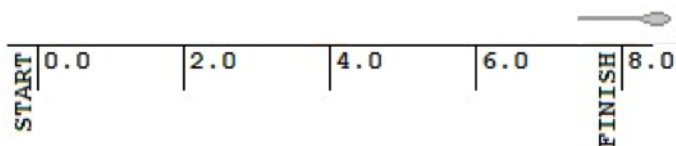

10. Press ACTION button to make measurement (fifth of five at 8.0 m position).

START 5/5
8.0 m

11. Completed. Accept, retry or cancel track scanning.

COMPLETED

MANUAL NAVIGATION IN CONTINUOUS MEASUREMENT MODE WITHOUT CHECKPOINTS

Track length = 8.0 m

1. Stay behind track beginning (-2.0 m position).



2. Start going towards track ending evenly.



3. Keep going to track ending. Press ACTION button at track beginning (0.0 m position) to start continuous measurement.

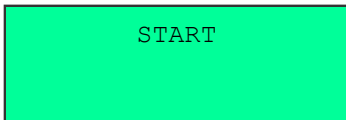

4. Keep going to track ending.

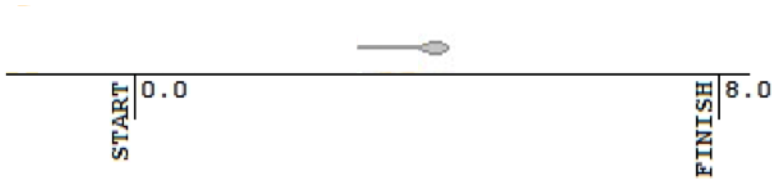

5. Press ACTION button at track ending (8.0 m position) to finish continuous measurement.

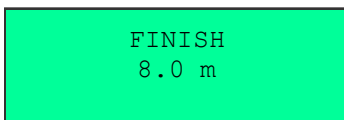

6. Completed. Accept, retry or cancel track scanning.

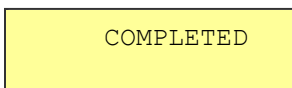

MANUAL NAVIGATION IN CONTINUOUS MEASUREMENT MODE WITH CHECKPOINTS

Track length = 8.0 m
Checkpoints distance = 3.0 m

1. Stay behind track beginning (-2.0 m position).

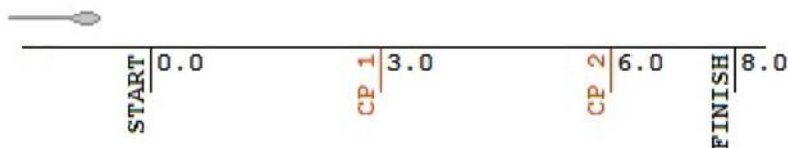

2. Start going towards track ending evenly.

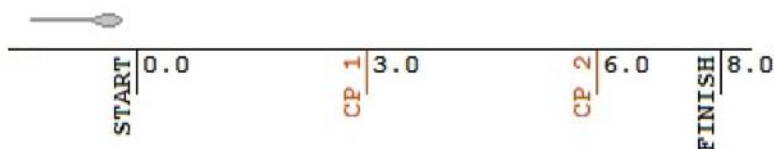

3. Keep going to track ending. Press ACTION button at track beginning (0.0 m position) to start continuous measurement.

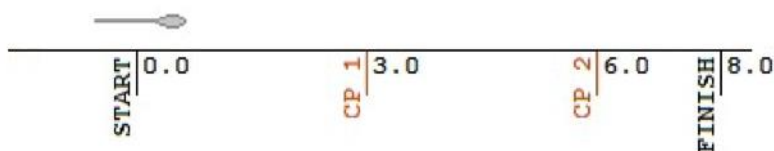

START
0.0 m

4. Keep going to track ending.

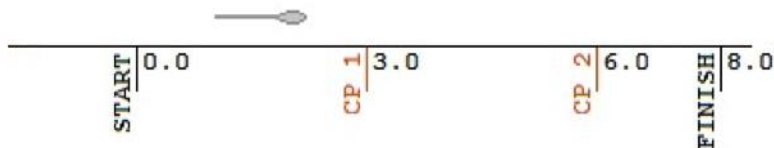

5. Keep going to track ending. Press ACTION button to mark checkpoint (first of two at 3.0 m position).

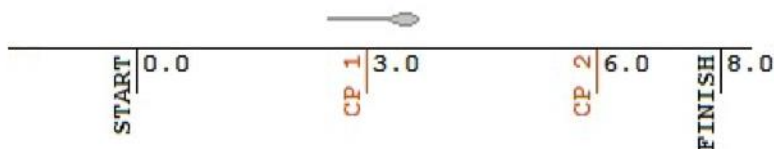

CHECKPOINT 1/2
3.0 m

6. Keep going to track ending.

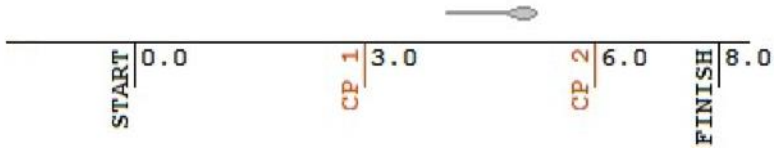

7. Keep going to track ending. Press ACTION button to mark checkpoint (second of two at 6.0 m position).

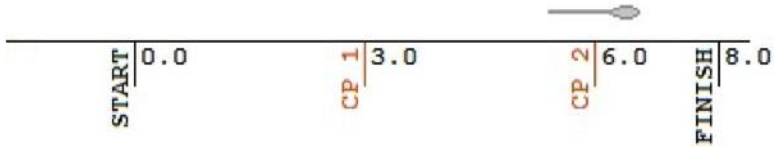

CHECKPOINT 2/2
6.0 m

8. Keep going to track ending.

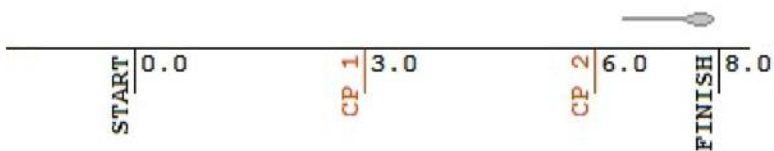

9. Press ACTION button at track ending (8.0 m position) to finish continuous measurement.

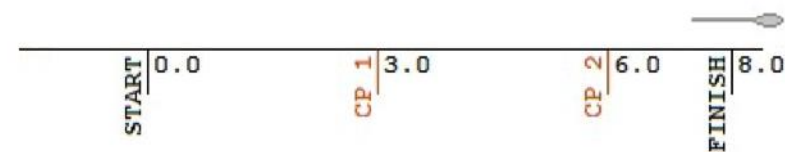

FINISH
8.0 m

10. Completed. Accept, retry or cancel track scanning.

COMPLETED

ODOMETER NAVIGATION IN SINGLE MEASUREMENT MODE

Track length = 8.0 m

1. Go to track beginning (0.0 m position).

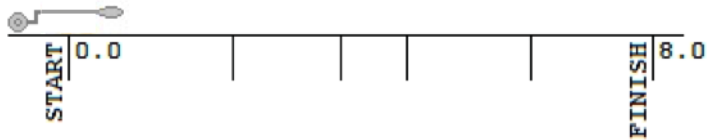

2. Press ACTION button to make measurement.

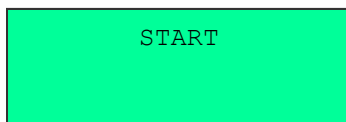

3. Go to next position (any position you like).



4. Press ACTION button to make measurement.

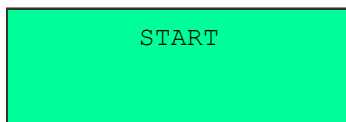

5. Repeat items 3 and 4 as many times as you like.



6. Cross track ending (8.0 m position) to complete automatically.



7. Completed. Accept, retry or cancel track scanning.

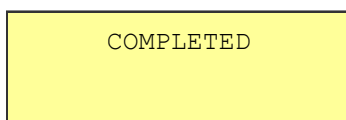

ODOMETER NAVIGATION IN CONTINUOUS MEASUREMENT MODE

Track length = 8.0 m

1. Stay behind track beginning (-2.0 m position).



2. Start going towards track ending.



3. Keep going to track ending. Press ACTION button at track beginning (0.0 m position) to start continuous measurement.

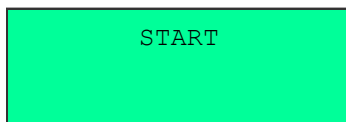
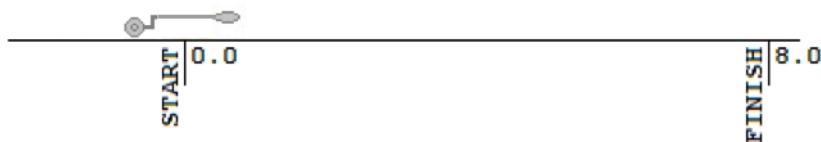

4. Keep going to track ending. You may press ACTION button to complete immediately.

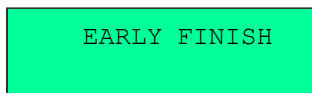
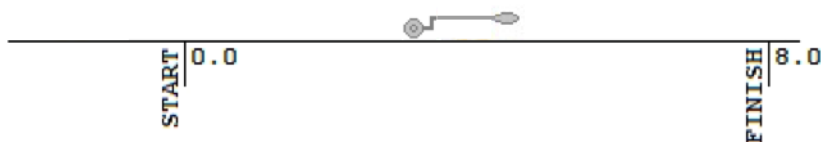

5. Cross track ending (8.0 m position) to complete automatically.



6. Completed. Accept, retry or cancel track scanning.

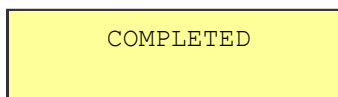

GPS / EXTERNAL GPS NAVIGATION IN SINGLE MEASUREMENT MODE

1. Go to track beginning (any position you like).

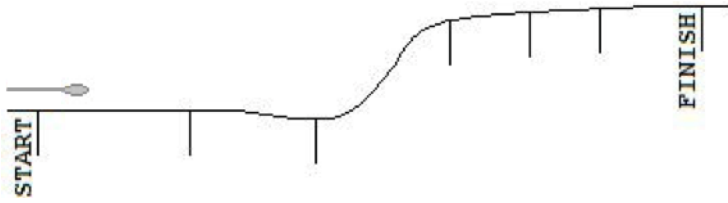

2. Press ACTION button to make measurement.

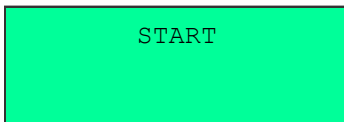

3. Go to next position (any position you like).

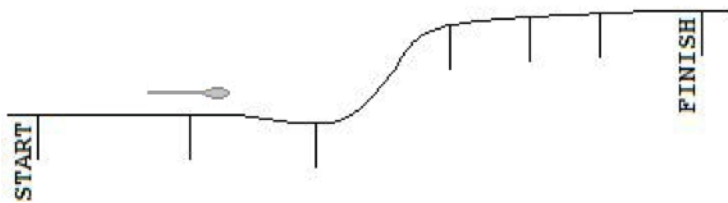

4. Press ACTION button to make measurement.

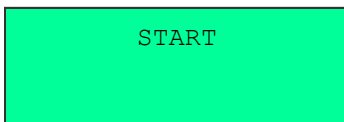

5. Repeat items 3 and 4 as many times as you like.

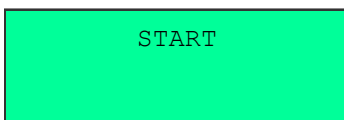
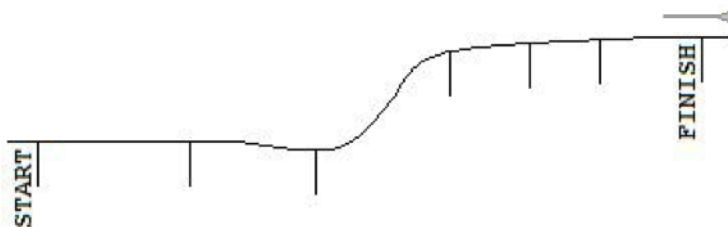

6. Completed. Accept, retry or cancel track scanning.

GPS / EXTERNAL GPS NAVIGATION IN CONTINUOUS MEASUREMENT MODE

1. Go to track beginning (any position you like).

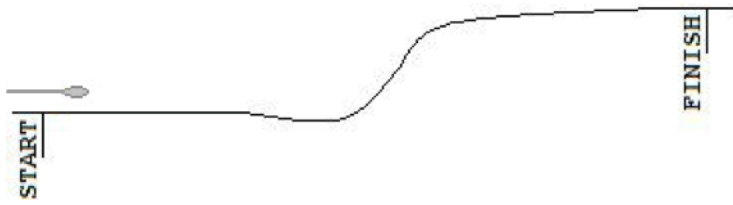

2. Press ACTION button to start continuous measurement.

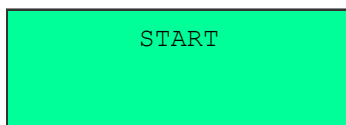
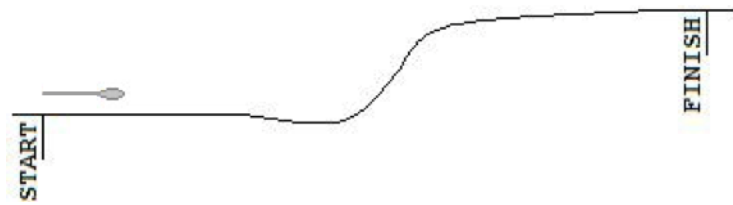

3. Keep going along track.

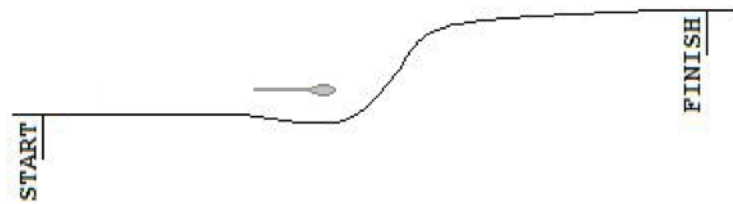

4. Press ACTION button at track ending (any position you like) to finish continuous measurement.

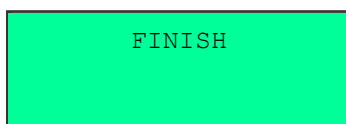

5. Press ACTION button to resume continuous measurement at any position you like.

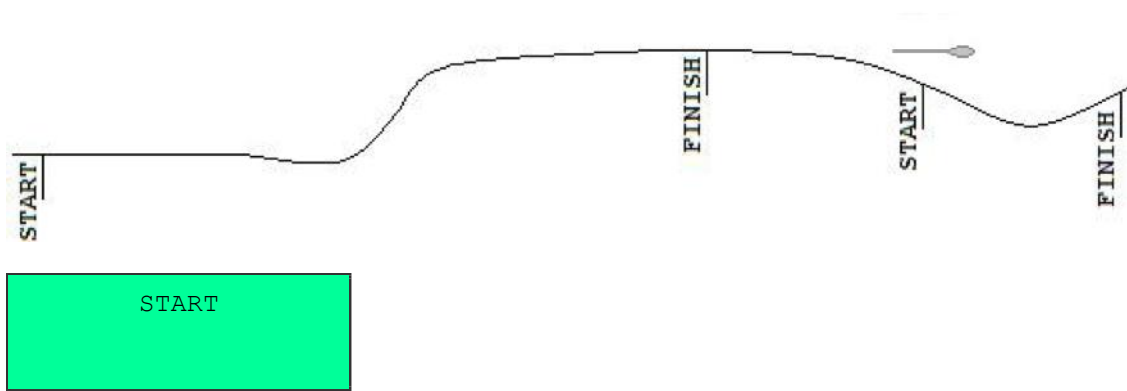

6. Completed. Accept, retry or cancel track scanning.

PC SOFTWARE – step 1

iiSystem

to preview and convert QZond measurement file to EMS file

Actual version could be found here: <https://nemfis.ru/aemp-14/?lang=en>

MAIN MENU

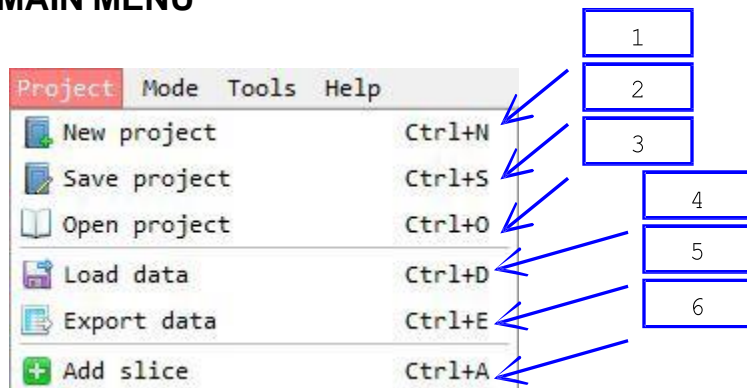

1. Create new project.
2. Save current project.
3. Open saved project.
4. Add data from QZS file to current project^[1].
5. Export current project data to other formats.
6. Add data slice^[2].

[1] This option is available in LAYOUT mode. [2] This option is available in SLICES mode.

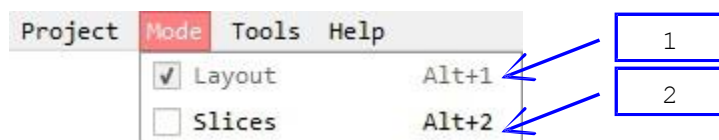

1. Use LAYOUT mode to add, remove, enable, disable and arrange tracks.
2. Use SLICES mode to view data as horizontal and vertical slices.

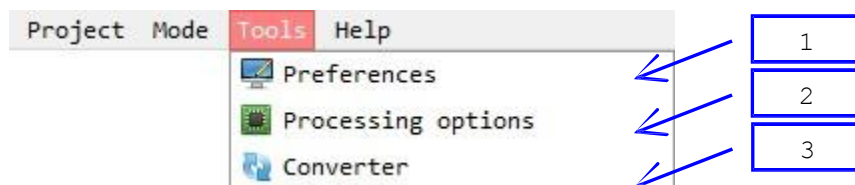

1. General preferences^[1].
2. Probe-specific data processing options^[1].
3. *.QZS to *.EMS converter. Choose file to convert. [1] This

option is available in LAYOUT mode.

TOOLS - PROCESSING

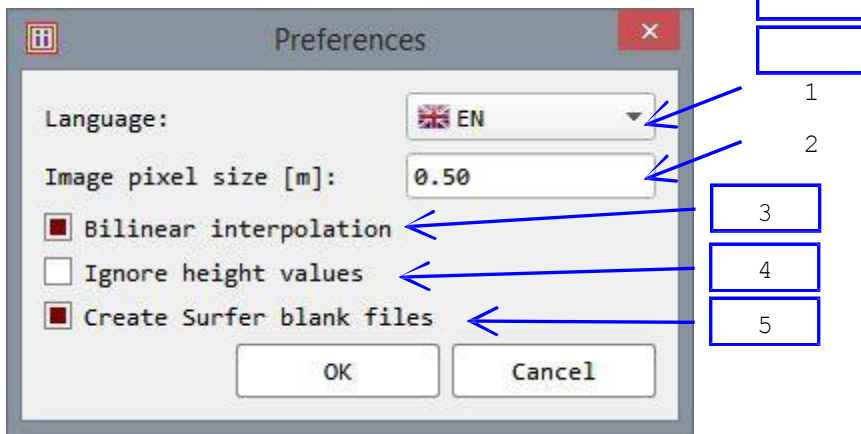

1. User interface language^[1].
2. Smaller values cause higher slices resolution and longer computation.
3. Bilinear interpolation causes higher image quality.
4. Assume that surface is flat.
5. Create BLN files when exporting to Surfer format. [1] Restart iiSystem

to apply.

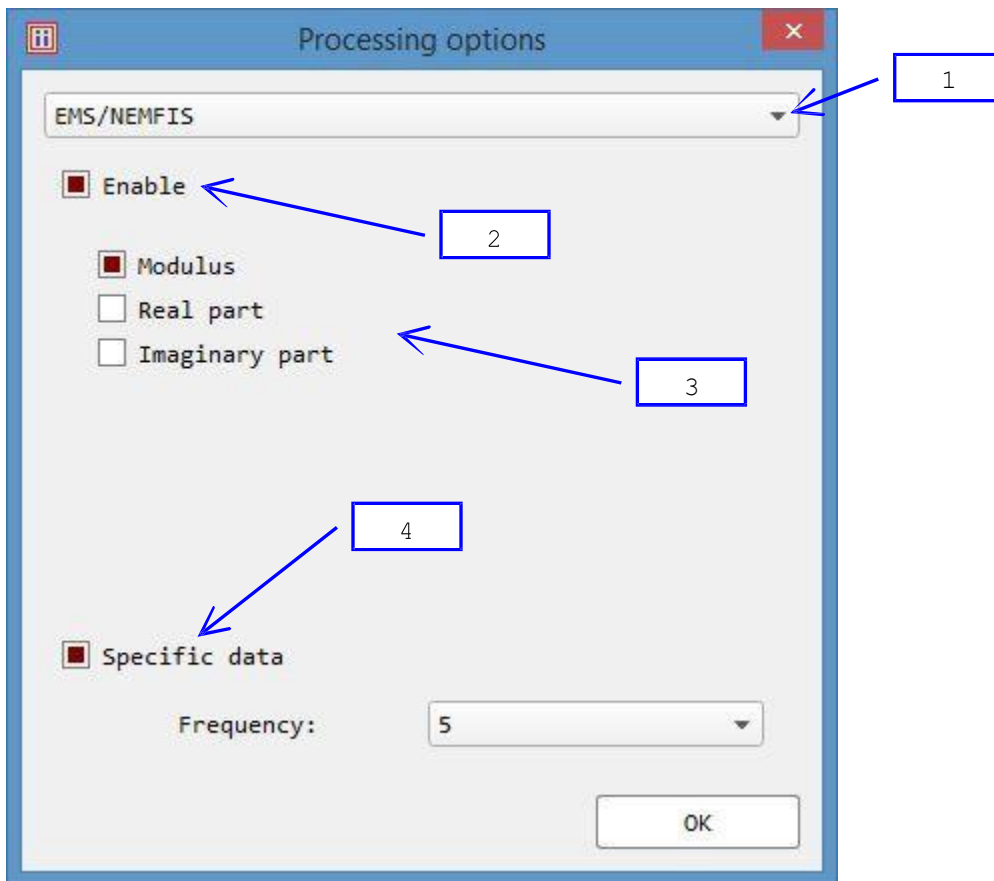

1. Choose probe.
2. Check to enable probe data.
3. Probe-specific data processing options.
4. Check to enable specific data only.

LAYOUT

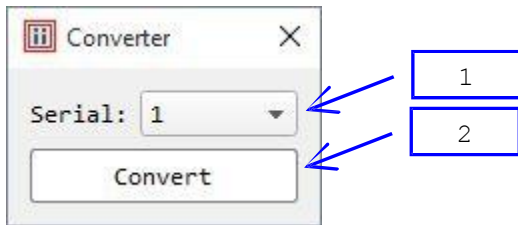

1. Choose EMS/NEMFIS serial number.
2. Create *.EMS file in same folder.

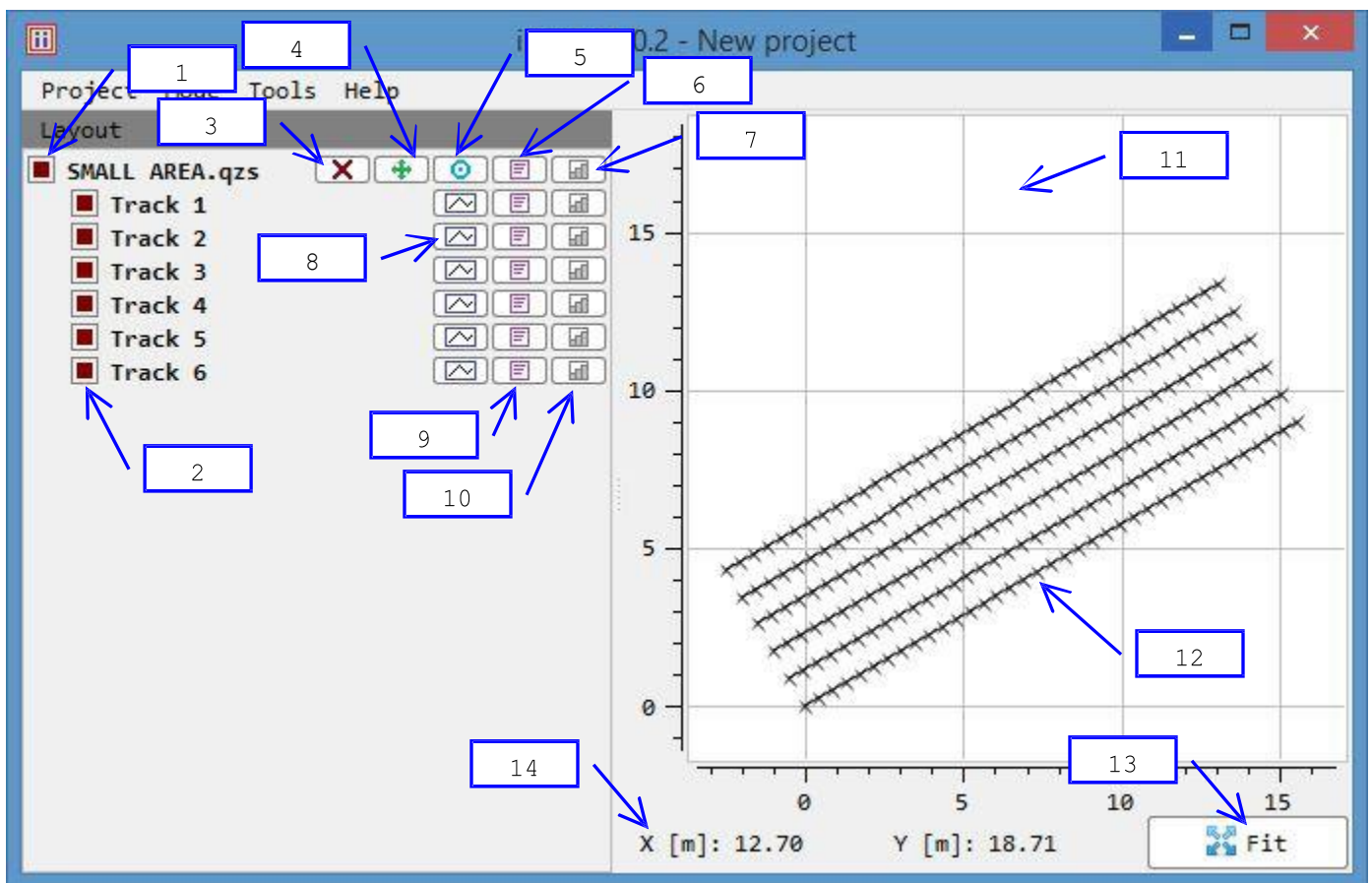

1. QZS file "SMALL AREA" is enabled.
2. QZS file "SMALL AREA" contains 6 tracks. All tracks are enabled.
3. Remove file.
4. Move all file tracks.
5. Rotate all file tracks around its first track beginning.
6. View file info.
7. View file resistivity bar chart.
8. View track profile.
9. View track info.
10. View track resistivity bar chart.
11. Map plot. Use left mouse button to pan and mouse wheel to zoom.
12. Tracks. Every measurement position is marked with "x" symbol.
13. Fit all tracks in map plot.
14. Current mouse pointer coordinates.

TRACK

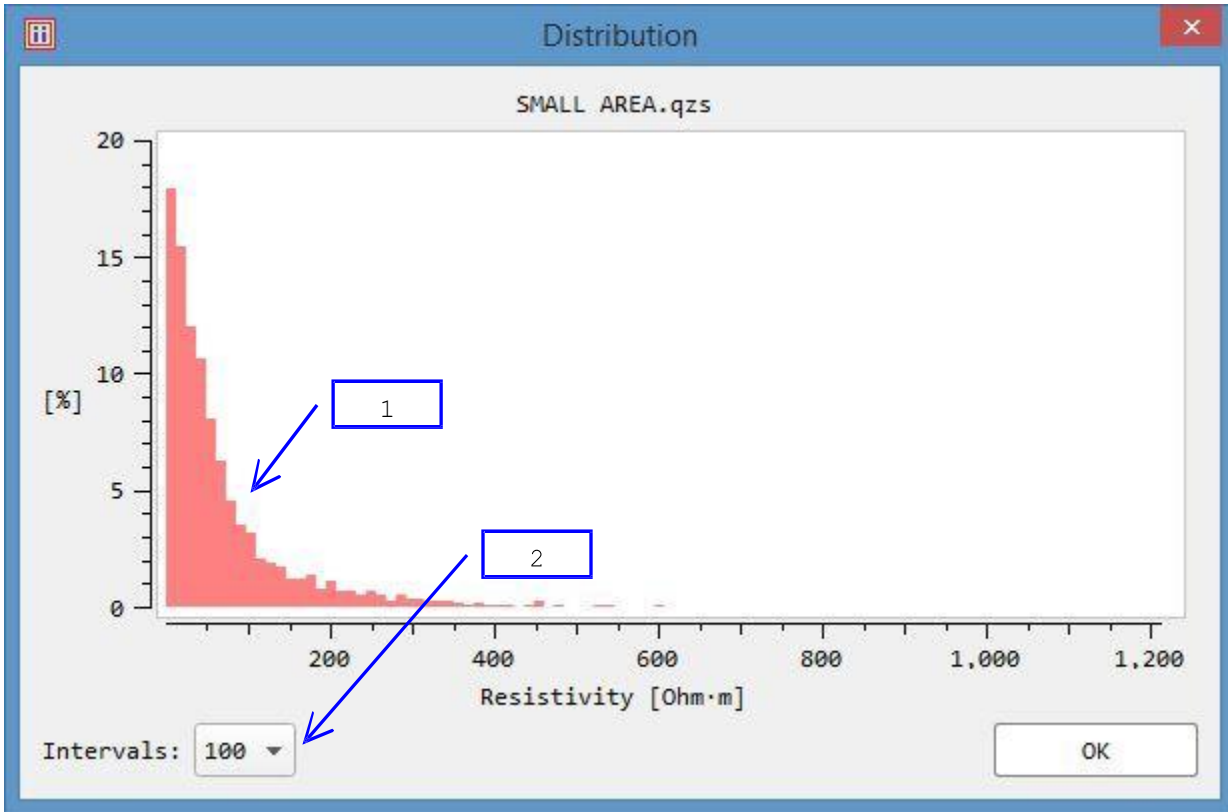

1. Bar chart.
2. Chart bars count.

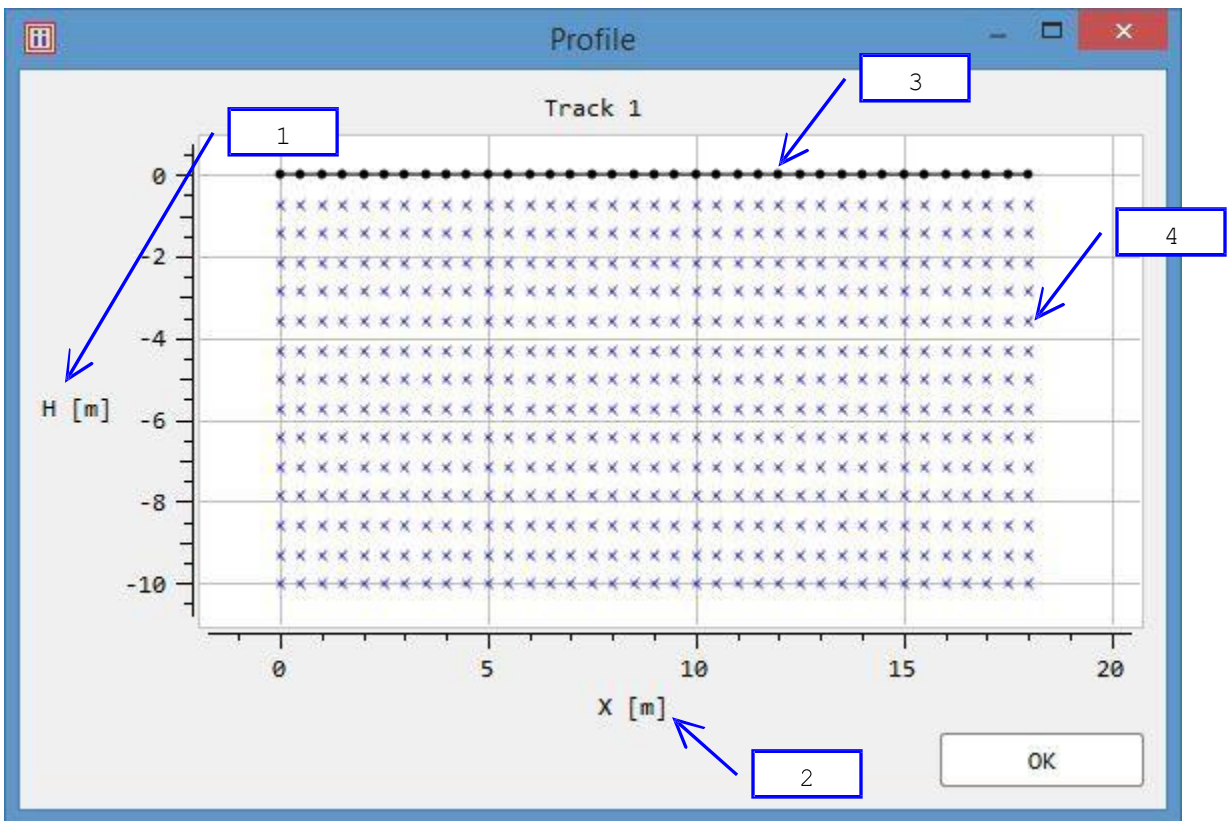

1. Height.
2. Horizontal position.
3. Every measurement position is marked with "o" symbol.
4. Every measurement is marked with "x" symbol.

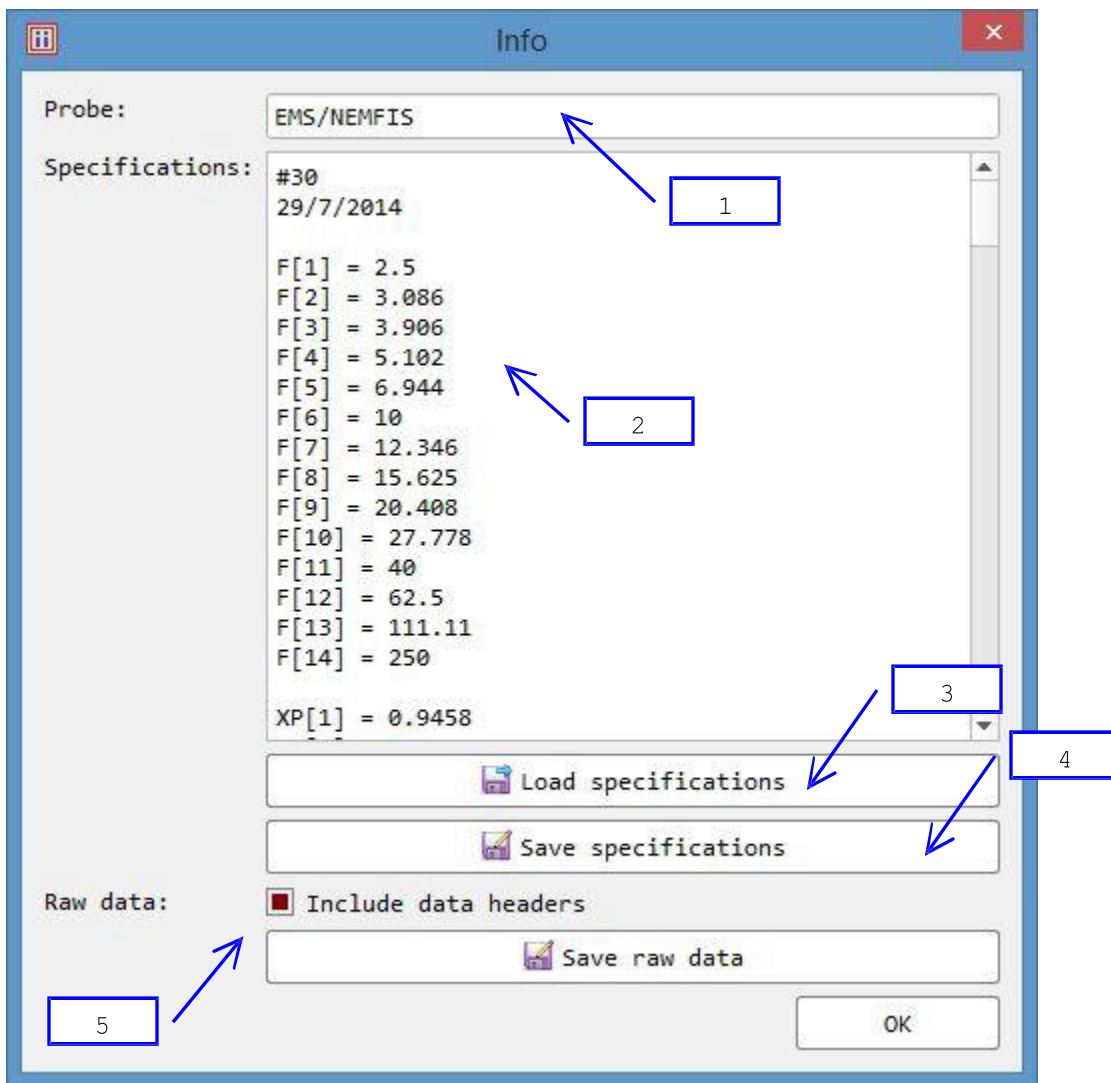

1. Probe used to scan track.
2. Probe specifications.
3. Replace current probe specifications with other ones.
4. Save current probe specifications.
5. Save probe raw data to table.

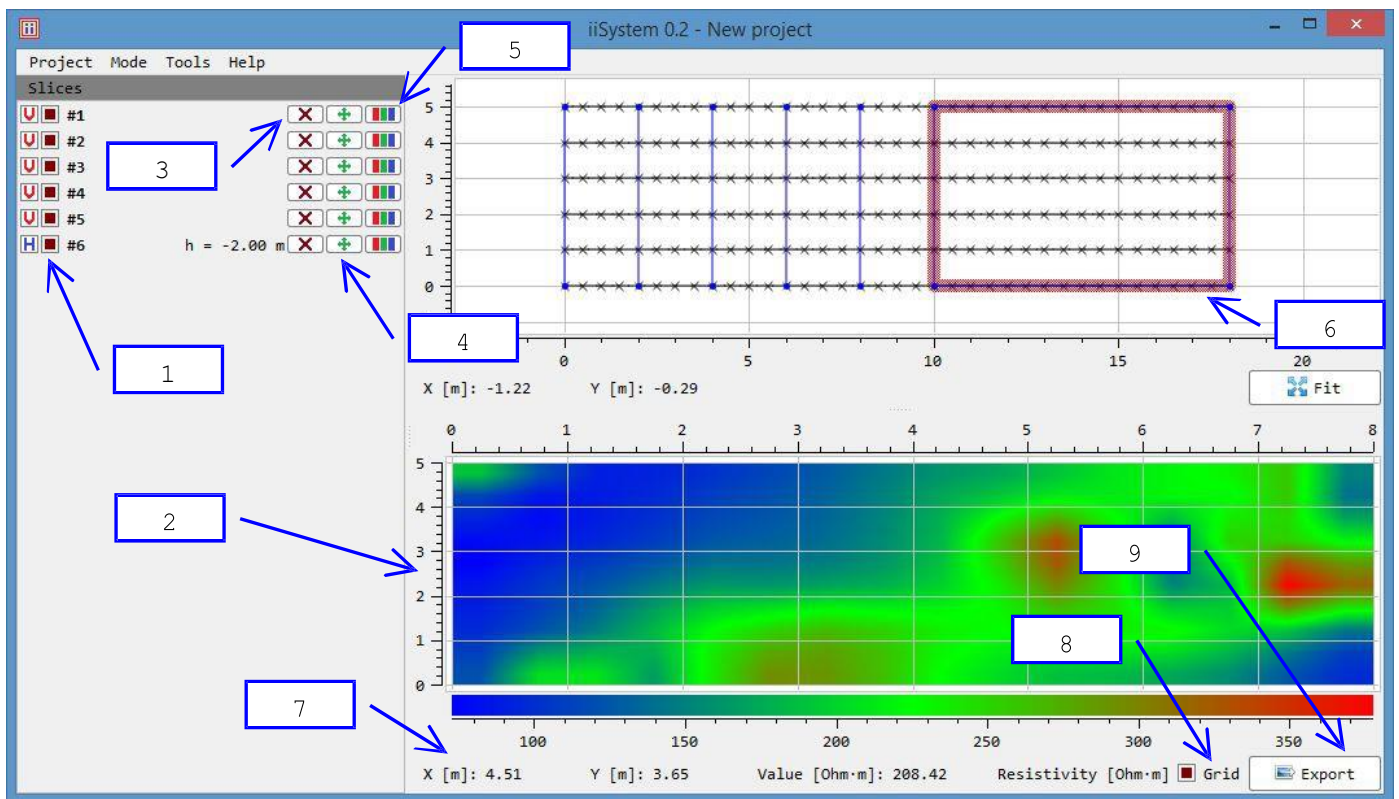

1. Project contains 6 slices. Slices #1 ... #5 are vertical^[1], slice #6 is horizontal^[1] at height -2.0^[2] m. All slices are shown as blue figures.
2. Slice view plot.
3. Remove slice.
4. Move slice.
5. View slice.
6. Horizontal slice #6 is currently shown.
7. Current mouse pointer coordinates and resistivity value.
8. Show grid.
9. Export current image to other formats.

[1] V = vertical, H = horizontal.

[2] In this project all tracks does not contain height data, so surface is located at height 0.0 m.

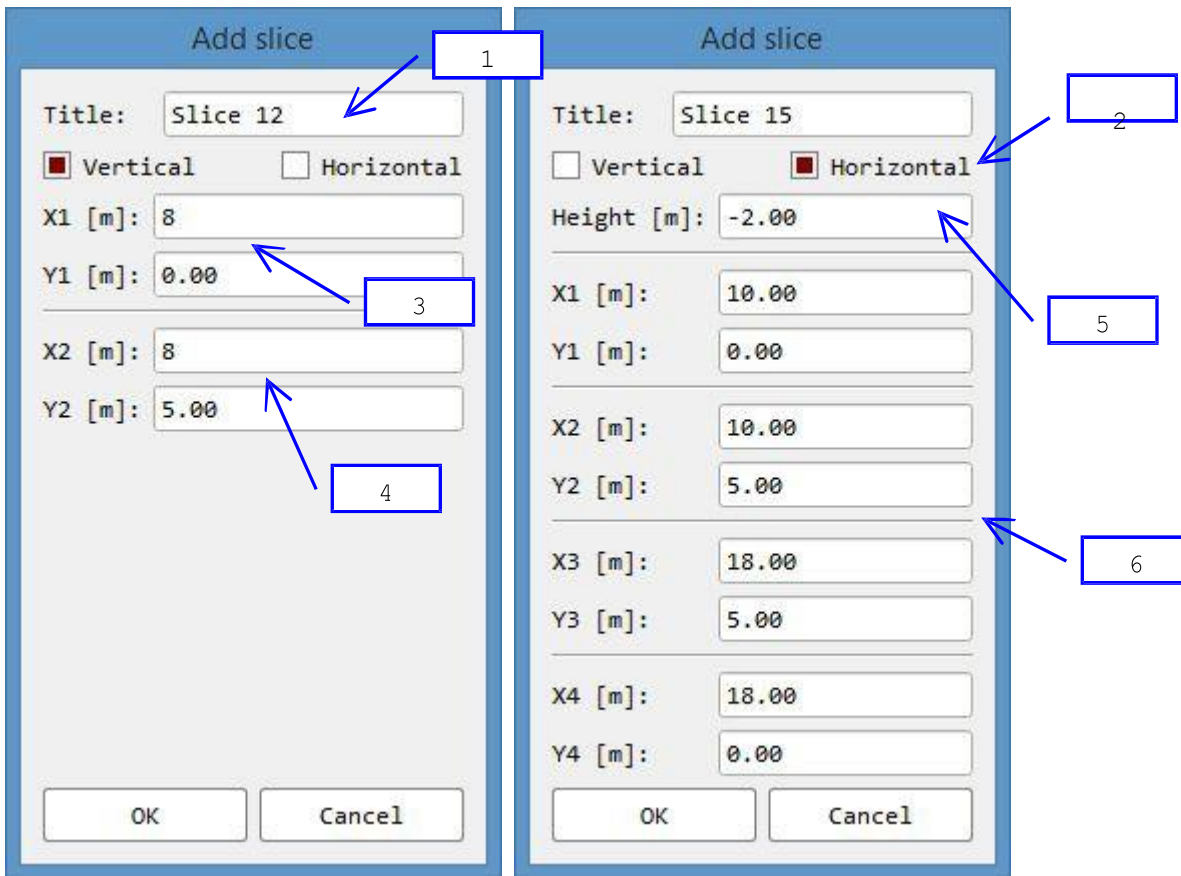

1. Slice title.
2. Slice orientation.
3. Vertical slice beginning coordinates.
4. Vertical slice ending coordinates.
5. Horizontal slice height.
6. Horizontal slice corner coordinates.

PC SOFTWARE – step 2

iSystem

is the specially created software for EMS files for data load, processing and automated visualization in *Golden Software Surfer v7.0x-12.x*.

iSystem Software

System requirements:

- Windows 98 or higher version
- Pentium MMX
- 16 Mb of RAM, recommended 64 Mb
- Display resolution 800x600, recommended 1024x768
- 20 Mb free on hard disk drive
- *Golden Software Surfer v7.0x-12.x* for automatic visualization (output maps and 3D models can be saved in Surfer format and opened manually in latest versions of Surfer and Voxler as well, however, automatic loading of output maps do not work so far (Aug 2016) in Surfer 13.0)
- *Adobe AcrobatReader* for EMS manual.

***I*System installation procedure**

If you don't have *Golden Software Surfer v7.0x-12.x* installed on your PC, install this product. Start *Surfer* at least once at your PC, choose metric system (*File/ Preferences/ Page Units*). Otherwise all the automatic visualization features of ***I*System** will be disabled.

Set symbol “.” as decimal point of your operation system (*Start/ Settings/ Control Panel/ Regional Options/ Numbers/ Decimal Symbol*).

Insert ***I*System** installation CD on your CD ROM drive, start installation program *ISystem30alpha.exe*, and follow the wizard's instructions. After the installation you will have the program icon on your desktop and working group with the ***I*System** program and help icons at your Programs panel.

To read the EMS manual install *Adobe AcrobatReader*.

Data load

To open .EMS file with EMS scanning (converted from QZond in *iiSystem*):

- 1) Run *I*system (*Start / Programs / ISystem*).
- 2) Set the orthogonal or chaotic grid using *Chaotic Grid* checkbox.
- 3) For orthogonal grid set the minimal and maximal numbers of stations and lines, line and station spacing.
- 4) * *On Site Description* fields type the site title, name of operator and your comments.
- 5) Press OK button. You can see the progress bar in the bottom-left corner of the window.
* Optional.

After downloading process the binary file *.ems will be created. If the site size does not matching to calculated number of records, you will be notified by corresponding message. Then you could change the site description. After the changing press Save button to write the data file.

Data processing

It is recommended to use quadrature component of signal. However, you can use in- phase one and modulus as well. The data can be normalized with the transmitter current and square of the frequency to make the readings closer to apparent conductivity. If you have made free-air measuring (zeroing), the zero-signal can be subtracted from the resulting signal. The

corresponding settings are used to be made on Processing Options dialog of Processing sub-menu of Options menu. We do recommend the full normalization and zero-signal subtraction for data processing. However, if result is not satisfactory, other regime can be tried.

The output file format can be changed using Output Parameters sheet at Processing Options dialog (Output Format switches).

If Output Format of datasheet is set, data are organized as 2-D array without coordinates, but keeping the position of data. In this case automated visualization can't be used. This format is convenient for diagrams building and visual analysis.

After cross-section processing the data is situated in the file as follow: rows include processed data of one frequency, columns include sounding result at one station, frequency is decreasing from top to the bottom.

During the processing the processing status file is to be created on default (corresponding checkbox is checked). The file includes missing stations, frequencies and lines numbers.

Orthogonal grid sounding results can be visualized as the set of maps according to the number of recorder frequencies, set of cross-section along and across the lines and diagrams.

Linear sounding can be visualized as cross-section and diagrams.

When all the processing options are set, maps, cross-sections and diagrams can be created. To create it, use a corresponding dialog from Tools menu, context menu or hot-key.

Maps

To create maps:

- 1) Open *Maps Process* dialog window using *Tools* menu, context menu or a hot-key on the main toolbar.
 - 2) Choose EMS data file (Data file). All the required fields of *Common Process* Window and *Maps Process* Window will be automatically filled. Output file name will be created automatically according to the chosen processing options. However, it can be changed. On the bottom part of the window you will see the panel corresponding to the grid mode.
 - 3) For Chaotic Grid mode create *.cdr file of the stations coordinates as follow: create text file with number of stations in the first row. Starting from the second row the file should include two columns with X and Y coordinates of stations. Save the file with cdr extension.
 - 4) If the Chaotic Grid mode is set, choose the appropriate grid coordinates *.cdr file.
 - 5) Choose the frequency of the map to be created in the *Maps Process* window or mark *All Frequencies* checkbox to create all the maps including and above the chosen frequency.
 - 6) * In the same window can be chosen minimal and maximal numbers of lines and stations to limit the processing part of studied site.
 - 7) * On the *Data Info* sheet *Common Process* Window you can change spacings between stations and/or lines.
 - 8) * Setting on the mirror checkbox you can flip the processing part on vertical or horizontal direction.
 - 9) * *Use Surfer* checkbox can be unchecked to create Grid file only.
 - 10) Push *Process* button. If *Use Surfer* checkbox is checked, after the processing you will see the visualization result at the Surfer window.
- *Optional.

Cross-sections

- 1) Call *Section Process* dialog from *Tools* menu, context menu or using the hot-key.
- 2) Choose EMS data file (Data file). All the required fields of *Common Process Window* and *Section Process Window* will be automatically filled. Output file name will be created automatically according to the chosen processing options. However, it can be changed. On the bottom part of the window you will see the panel corresponding to the grid mode.
- 3) At the *Section Process* window set the cross-section direction across or along lines. Set the appropriate numbers of line or station or check *All Sections* checkbox to create all the cross-sections.
- 4) * At the same window can be chosen minimal and maximal numbers of lines and stations to limit the processing part of studied site.
- 5) * On the *Data Info* sheet of *Common Process Window* you can change spacing between stations and/or lines.
- 6) * At the same window can be checked the X and Y Mirror checkbox to create mirrored view.
- 7) * *Use Surfer* checkbox can be unchecked to create Grid file only.
- 8) * After pressing of *Options* button *Process Options* menu will appear. The menu can be used to change data export, settings and visualization parameters of Surfer.
- 9) * Optional.

Automatic visualization of maps and cross-sections.

After the above described data processing the resulting files are ready for use with graphic processing software. *ISystem* featured automatic visualization with *Golden Software Surfer*. To activate this feature, check *Use Surfer* checkbox in the *Common Process* window before pressing of *Process* button.

Note: If *Output Format* switch at the *Output* sheet of *Process Options* dialog is set to *Datasheet mode*, *Surfer* automatic visualization is disabled.

If *Create and Show Map* checkbox is unchecked, the process will be stopped after grid files creation. It is useful for topographed cross-section, for further topographic data overlay (see below).

If all the checkboxes of *Use Surfer* group are checked, the software creates grid files, document and image. All the files save in the chosen directory and the image opens in *Surfer* window.

Surfer settings

For Surfer settings *SurfOpt* and *SurfPage* sheets of *Process Settings* dialog are to be used.

Surfer on default selects more or less equal steps for the both direction of 2-D grid. That's why if your study area shape is essentially different from square, it's very useful to change number of vertical or horizontal fragments of your image. It can be done using *NumRows* and *NumColumns* parameters on the *SurfOpt* sheet.

For the automatic visualization Radial Basis Functions method is used. Precision of this method depends of *RSquared* parameter that can be set on *SurfOpt* sheet. *MajorInterval* parameter is the spacing between ticks and labels on the axis. For the detailed description of *Surfer* parameters see *Surfer* help.

SurfPage sheet includes page parameters such as size, orientation and margins.

Diagrams

When *Diagram process* is chosen from *Tools* menu, context menu or by the hot-key, *Section Process* dialog opens, and *Output Format* switch at the *Output* sheet of *Process Options* dialog is set to *Datasheet* mode. After the processing, operator can use resulting datasheet to build diagrams using any software such as MS Excel and so on.

Cross-section with Topography**

To create cross-section with surface relief:

- 1) Create grid file of the cross-section as described at **Cross-section** and **Automatic visualization of maps and cross-sections** paragraphs.
- 2) Create text file with topographic data. The file must include number of points in the first row. Starting from the second row the file should include two columns with X and Z coordinates of surface.
- 3) Open *Relief Section* dialog from *Tools* menu, context menu or by pressing the hot-key.
- 4) Choose the grid file of the section to be build. *XMin*, *XMax*, *YMin*, and *YMax* fields of *Relief* sheet will be filled automatically. Now topo file can be chosen.
- 5) Choose the topographic data file. Using checkbox *Preview Relief* it's possible to see the interpolated relief curve on the preview window.
- 6) * Choose interpolation method in *Interp Method* listbox.
- 7) * If vertical scales of the cross-section and relief curve do not match, they can be equalised using *Scale Coefficients*. It could be useful if you are working with metric system and your topographer – with US system.
- 8) * The resulting file name is creating automatically, but it can be changed.
- 9) * *Common Settings* panel contains *Distance Between Relief and Section* parameter. Since the EMS sounding depth has an upper limit (approx. 10- 20 cm for highest frequency), it makes sense to put your cross-section a bit deeper than surface level.
- 10) Press *Process* button. After completion message switch to *Surfer* window to see the result.

* Optional

** Enabled only if *Output Format* switch at the *Output* sheet of *Process Options* dialog is set to *Surfer Data Files* mode.

Document Set creation**

To create document set:

- 1) Open *Create Multi Map Documents* window from *Tools* menu or context menu or using the hot-key.
- 2) On the *Input* panel set the *.dat files created by *ISystem*. The files will be sorted in inverse order for appropriate quazi 3D presentation.
- 3) Set *Single Map Document* on.
- 4) *Set the *Surfer* parameters (see **Automatic visualization of maps and cross-sections**) in the *Process Options* window using *Surfer Options* button.
- 5) Press *Process* button. After completion message switch to *Surfer* window to see the result. For each of choosen in item 2) files will be created image and open in separate window.

* Optional

** Enabled only if *Output Format* switch at the *Output* sheet of *Process Options* dialog is set to *Surfer Data Files* mode.

Quazi 3D view.**

ISystem can be used to present your results as sliced cube of data. The cube can be slided in horizontal (multi map) or vertical (multi cross-section) direction. All the slices can be presented in proper order in one window. We do call this presentation as quazi 3D view.

- 1) Open *Create Multi Map Documents* window from *Tools* menu or context menu or using the hot-key.
- 2) On the *Input* panel set the *.dat files created by *ISystem*. The files will be sorted in inverse order for appropriate quazi 3D presentation. The high frequency has smaller penetration depth.
- 3) * Set *Multi Map Document* on.
- 4) * Set parameters of the maps layout on the page using *Multi Maps Options* dialog. On *Placement* sheet set number of rows and columns of the maps layout, spacing between them. To use 3D view, check *Apply* checkbox on 3D view sheet. All the parameters on this sheet are set to get the best layout. For more detailed description of 3D view parameters see Surfer help.
- 5) *Set the *Surfer* parameters (see **Automatic visualization of maps and cross-sections**) in the *Process Options* window using *Surfer Options* button.
- 6) Press *Process* button. After completion message switch to *Surfer* window to see the result.

* Optional

** Enabled only if *Output Format* switch at the *Output* sheet of *Process Options* dialog is set to *Surfer Data Files* mode.

Examples

ISystem installation package includes the set of examples. They are situated in *Samples* sub-directory.

- **Chaotic grid map.** Sub-directory *\Samples\Chaotic Grid Maps Sample* includes data file of sounding on chaotic grid. Grid coordinates are stored on *coordinates.crd* file.
- **Topographic relief.** Grid-file based on sounding data along the line crossing a ditch with a brook is situated in *\Samples\Relief Cross Section Sample*. Topographic data file and processing result can be found at the same sub-directory.
- **Quazi 3D view.** Sub-directory *\Samples\Multi Map Sample* includes areal sounding data.